

1 Fusibles Media Tensión High Voltage Fuses



Los fusibles MT (Media Tensión) son utilizados como elementos de protección en aparata de media tensión. La gran ventaja es la rapidez de actuación en caso de cortocircuito. En consecuencia, protegen eficazmente la aparata y los equipos contra los efectos dinámicos y térmicos del cortocircuito.

Los fusibles SIBA MT cumplen con las siguientes normas y especificaciones:

- IEC 60282-1 / VDE 0670 parte 4
- IEC 60787 / VDE 0670 parte 402
- DIN43625
- IEC 60644 / VDE 0670 parte 401
- IEC 60549
- IEC 62271 parte 105

High-voltage fuse-links (HV fuse-links) are used as protection devices in medium voltage switchgear. The great advantage is the very fast current limiting operation in the event of short-circuit failures. Consequently, they protect switchgear and equipment against dynamic thermal effects of such shortcircuits in a very effective way.

SIBA HV fuse-links comply with the following standards:

- IEC 60282-1 / VDE 0670 Part 4
- IEC 60787 / VDE 0670 part 402
- DIN43625
- IEC 60644 / VDE 0670 part 401
- IEC 60549
- IEC 62271 part 105

Presentación gama HH / HH range overview.....	16
Ventajas / Features	19
Gama / Range	20
HHD-B Fusibles de acompañamiento de media tensión / HHD-B HV-Back-Up fuse links	20
3 / 7,2 kV	20
6 / 12 kV	22
10 / 17,5 kV	24
10 / 24 kV	26
20 / 36 kV	28
HHD-BSSK Fusibles de acompañamiento de media tensión / HHD-BSSK HV-Back-up fuse links	29
6 / 12 kV	29
10 / 24 kV	29
20 / 36 kV.....	29
Bases para fusibles de media tensión 7,2-36 kV / High voltage fuse bases 7,2-36 kV	30
Accesorios / Accessories	31
Curvas / Time current characteristics	35
HHD-B	35
3 / 7,2 kV "e" = 192 mm	35
6 / 12 kV "e" = 292 mm	36
10 / 17,5 kV "e" = 367 mm	37
10 / 24 kV "e" = 442 mm	38
20 / 36 kV "e" = 537 mm	39
HHD-BSSK	40
6 / 12 kV "e" = 292 mm	40
10 / 24 kV "e" = 442 mm	41
20 / 36 kV "e" = 537 mm	42
Recomendaciones de uso / Recommendations for application	45

Presentación gama HH / HH range overview



HHD

Fusibles según normativa DIN
Fuse Links according DIN Standard

Fusibles de protección de transformadores y condensadores
Fuses for the protection of transformers and capacitors

HHD-B

Fusibles de acompañamiento. Protección clásica de transformadores de potencia y distribución (<2000 kVA).

A classical standard back-up fuse for transformer protection and distribution (<2000 kVA).

Tensión Nominal Rated Voltage (kV)	Intensidad Nominal Rated Current (A)
3 / 7,2	6,3-500
6 / 12	6,3-315
10 / 17,5	6,3-200
10 / 24	6,3-200
20 / 36	6,3-100
27	6,3-125
38,5	6,3-63
40,5	6,3-63

HHD-BSSK

Fusibles de acompañamiento SSK. Protección especial para grandes transformadores de distribución (≥ 630 kVA) con bajas pérdidas.

Back-up SSK fuses can be used for transformers with higher power ratings (≥ 630 kVA) with low power losses.

Tensión Nominal Rated Voltage (kV)	Intensidad Nominal Rated Current (A)
6 / 12	63-160
10 / 24	63-125
20 / 36	63-80

HHD-G

Protección de propósito general frente a sobrecargas.

HHD-G fuses are therefore deployed for overload-protection purposes.

Tensión Nominal Rated Voltage (kV)	Intensidad Nominal Rated Current (A)
6 / 12	6,3-100
10 / 24	6,3-40

Fusibles de protección o motor

Fuses for the protection or motor circuits

HHD-BM

Fusible de acompañamiento. Protección de motor. Protección clásica de motores de bajas pérdidas.

This type series consist of back-up fuses for motor circuit protection. Power dissipation is much lower compared to commonly used HV fuses.

Tensión Nominal Rated Voltage (kV)	Intensidad Nominal Rated Current (A)
3 / 3,6	50-450
3 / 7,2	50-450
6 / 12	50-200

HHD-BR

Fusible de acompañamiento. Protección de motor tipo R. Protección especial "a medida" de motores de acuerdo a estándar ANSI C37,46.

Back-up. Motor circuit protection R-rated. Special motor circuit protection tailored to meet the ANSI C37,46 standard.

Tensión Nominal Rated Voltage (kV)	Intensidad Nominal Rated Current (A)
2,4 / 7,2	70-700

Fusibles de protección de transformadores de tensión

Fuses for the protection of voltage transformer circuits

HHD-BVT

Fusible de acompañamiento. Protección de transformadores de tensión de medida y protección.

Back-up. Voltage Transformer Protection.

Tensión Nominal Rated Voltage (kV)	Intensidad Nominal Rated Current (A)
3 / 7,2	0,5-5
6 / 12	0,5-5
10 / 17,5	0,5-5
10 / 24	0,5-5
20 / 36	0,5-5
27	0,5-5
38,5	0,5-5
40,5	0,5-5

Fusibles estándar británico

Fuse links British Standard

Fusibles para inmersión en aceite

Fuse links for oil insulated switchgear

HHBO-B

Fusible de acompañamiento. Utilización inmersión en aceite. Protección en interruptores de aceite hasta 24 kV.

Back-up. Use under oil. Protection for oil insulated switchgear up 24 kV.

Tensión Nominal Rated Voltage (kV)	Intensidad Nominal Rated Current (A)
7,2	6,3-145
12	6,3-145
25,5	6,3-80
24	6,3-80

HHB

Fusibles protección de motor

Fuses for the protection of motor circuits

HHBM-BM

Fusible de acompañamiento. Protección de motores de bajas pérdidas. Back-up. Motor circuit protection. The power loss in connection of this fuse-links is much lower compared to commonly used HV fuses.

Tensión Nominal Rated Voltage (kV)	Intensidad Nominal Rated Current (A)
3,6	50-450
7,2	25-450



HHF

Fusibles estándar francés
Fuse links French Standard

HHD-B

Fusibles de acompañamiento según UTE. Protección de transformadores de potencia.
Back-up according UTE. Protection of power transformers.

Tensión Nominal Rated Voltage (kV)	Intensidad Nominal Rated Current (A)
24	6,3-63

HHA

Fusibles estándar americano
Fuse links American Standard
Fusibles para protección de baterías de condensadores
Fuse-links for the protection of capacitor circuits

HHA-BC

Fusible de acompañamiento. Protección especial de condensadores.
Back-up. Capacitor protection.

Tensión Nominal Rated Voltage (kV)	Intensidad Nominal Rated Current (A)
4,8	6,3-250
7,2	6,3-200
15,5	6,3-100
5,5	6,3-200
8,3	6,3-125
23	6,3-50

HHX

Fusibles especiales
Special Fuse-links
Fusibles para la protección de transformadores de potencia en aceite
Fuses for the protection of oil insulated main transformers

HHOZ-B

Fusible de acompañamiento. Sellado para inmersión en aceite. Protección especial de transformadores de distribución mediante fusible inmerso en aceite.
Back-up. Oiltight.

Tensión Nominal Rated Voltage (kV)	Intensidad Nominal Rated Current (A)
12	6,3-125
24	63-80
36	10-40

Fusibles de protección de transformadores de tensión
Fuses for the protection of voltage transformer circuits

HHOD-B

Fusible de acompañamiento. Sellado para inmersión en aceite. Estándar DIN. Protección especial de transformadores de distribución mediante fusible inmerso en aceite. Solamente disponible para 24 kV.
Back-up. Oiltight. DIN standard. These back-up fuses are designed for the use under oil within the transformer. This fuse is available for a rated voltage of 24 kV.

Tensión Nominal Rated Voltage (kV)	Intensidad Nominal Rated Current (A)
24	16-31,5

Fusibles con conexiones en cabecera de líneas
Fuses with overhead line connectors

HHOZ-G

Propósito General. Sellado para inmersión en aceite. Protección especial de transformadores de distribución mediante fusible inmerso en aceite.
General Purpose. Oiltight.

Tensión Nominal Rated Voltage (kV)	Intensidad Nominal Rated Current (A)
12	8-63
17,5	10-24
24	8-40

HHZ-BVT

Protección especial de transformadores de tensión de medida y protección.
Back-up Volt. Transformer protect.

Tensión Nominal Rated Voltage (kV)	Intensidad Nominal Rated Current (A)
3 / 7,2	1-5
6 / 12	1-5
10 / 17,5	1-5
10 / 24	1-5
20 / 36	1-3

HHP-B

Protección especial para transformadores en poste.
Back-up Overhead Line Fitting.

Tensión Nominal Rated Voltage (kV)	Intensidad Nominal Rated Current (A)
24	32



NUEVOS FUSIBLES HH CON ICS (ESTABILIDAD CÍCLICA MEJORADA)

Después de un largo estudio y feedback de los clientes durante varios años, SIBA descubrió que en el caso de aplicaciones especiales de transformadores como turbinas eólicas y fotovoltaica, la carga cíclica puede dañar a lo largo de los años fusibles estándares de media tensión. Además, son muchos los componentes que se ven afectados por este asunto: los embarrados y las conexiones eléctricas, los fusibles pueden quedar pre-dañados, etc.

Por lo tanto, SIBA decidió añadir la función ICS a los fusibles que están destinados para tales aplicaciones. Esta nueva característica proporciona un sistema de elementos de fusión que es mucho más estable frente a las cargas cíclicas según lo mencionado por IEC / TR 62655 en el caso de "transformadores para aplicaciones eólicas".

Lo más importante es que los fusibles proporcionarán la estabilidad mejorada sin cambiar ningún parámetro eléctrico ni dimensional. Todos los valores como Itransfer, pérdidas, Imin, etc. permanecerán sin cambios.

Dado que esta función (ICS) está siendo introducida paso a paso en la gama completa de fusibles HH, contacte con su distribuidor comercial para asegurarse de que cualquier referencia individual dispone de esta nueva característica. Además, los tipos correspondientes están marcados en la hoja de datos técnicos.

NEW HH FUSES WITH ICS (IMPROVED CYCLIC STABILITY)

After a long study and customer feedback over several years SIBA found out that in case of special transformer applications like wind turbines and photovoltaic, cyclic load is able to damage standard HV fuses over the years. Moreover, a lot of components are affected by this matter, burbars and connections are breaking, fuses are pre-damaged, etc.

Therefore, SIBA decided to add the ICS feature to those which are intended for such applications. This new ICS feature provide a melting-element system being much more stable against cyclic loads as mentioned by IEC / TR 62655 in case of "Transformers for wind application".

The most important thing is, that the fuse will provide the improved stability without changing any electrical and dimensional parameter. All values like Itransfer, Power-loss, Imin, etc. will remain completely unchanged.

Since ICS is being introduced step by step to te complete range of HH Siba fuses, just contact your commercial dealer in order to be sure of any single reference having this new feature. Also, the corresponding types are marked in the technical data sheet.

INDICACIÓN DE CORRIENTE RÁPIDA FAST CURRENT INDICATOR

Los fusibles SIBA HV poseen elementos de fusible de plata conectados en paralelo. El diseño y el método de producción de los elementos garantizan la concordancia con las características tiempo- corriente.

SIBA HV-Fuses have parallel connected pure silver fuse elements. The design and method of production of the elements ensure narrow tolerances of time-current characteristics

Gran fiabilidad debido a los avanzados y controlados procesos de fabricación

High service reliability because of advanced controlled fabrication process

Numerosos años de experiencia probada en este campo.
Many decades of positive field experience

Bajas pérdidas y bajos incrementos de temperatura.
Low power losses and respectively, low temperature rise.

Gran capacidad de corte / High breaking capacity

Baja tensión de arco / Low switching voltage

Sistema fiable de estanqueidad contra la humedad, el polvo y la corrosión.

Reliable sealing system against humidity / dust and corrosion.

Ausencia de envejecimiento / Free of ageing



Los elementos del fusible se enrollan sobre un soporte de cerámica y se unen a las tapas de conexión enchapados en plata por medio de soldadura por puntos. Las tapas de conexión están instaladas dentro de las tapas de plata de cobre chapado en un extremo mediante la soldadura por puntos. Las tapas de cobre se colocan a presión en el tubo de porcelana, que es de cristal por dentro y por fuera. Las tapas son fijadas mecánicamente al tubo de porcelana y selladas por un soporte elástico duradero.

The fuse elements are wound on a ceramic support and are attached to the silver plated connection caps by means of spot-welding. The connection caps are fitted inside the silver plated copper end caps by spot welding. The copper end caps themselves are press-fitted onto the porcelain tube, which is glazed inside and outside. The end caps are mechanically fixed to the tube of techn. porcelain and additionally sealed by a durable elastic sealing medium.

Los fusibles MT de SIBA pueden ser utilizados para la protección de:

- Transformadores de distribución
- Motores de media tensión
- Condensadores de media tensión
- Transformadores de tensión
- Cables de alimentación

SIBA HV fuse-links can be used for the protection of:

- Distribution transformers
- Motor circuits
- Capacitor banks
- Voltage transformers
- Cable feeders



Los fusibles MT de SIBA son apropiados para instalarse en:

- Aparata de interior, aislada con aire/gas
- Aparata de intemperie
- Servicio bajo condiciones climáticas severas
- Instalación en aparata aislada con aceite
- Instalación dentro de transformadores de distribución con aislamiento de aceite.

SIBA HV fuse-links are suitable for:

- Indoor switchgear, air- and gas-insulated
- Outdoor switchgear
- Overhead lines service under severe climatic conditions
- Installation in oil-insulated switchgear
- Installation inside distribution transformers under oil

Fusibles de acompañamiento de media tensión HV – Back-Up fuse links

Gama / Range

HHD-B

3 / 7,2 kV



Tensión Nominal Rated Voltage	Dimensiones Dimensions		Intensidad Nominal Rated Current	Referencia Reference	Peso Weight	Poder de Corte Rated Breaking Current I_1	Intensidad Mínima Fusión Min. Breaking Current I_3	Prearco Pre-Arcing I^2t	I^2t Total Total I^2t -Value		Pérdidas Power Loss	Resistencia en frío Cold Resistance					
	Longitud Length "e"	ØD							U_n min	U_n max							
kV	mm	mm	A		kg/1	kA	A	A ² s	A ² s	A ² s	W	m Ω					
3 / 7,2	192	53	0,5	30 002 11.0,5	1,2	63	5	1,6	3,2	5,9	3,6	13.250					
			1	30 002 11.1			8	0,63	1,8	2,8	2,8	2.100					
			2	30 002 13.2			16	3,2	9,8	12	5,0	935					
			2,5	30 002 13.2,5			20	7,2	14,5	22	5,2	630					
			3,15	30 002 13.3,15			24	17	32	48	5,5	420					
			4	30 002 13.4			32	31	62	90	7,2	310					
			5	30 002 13.5			40	40	80	125	5,0	141					
			6,3	30 002 13.6,3			22	45	210	360	10	178					
			10	30 002 13.10			34	75	350	560	17	113					
			16	30 002 13.16			56	250	1.100	2.000	17	50					
			20	30 002 13.20			70	640	2.900	4.800	13	27					
			25	30 002 13.25			90	1.050	4.700	7.500	16	21					
			31,5	30 002 13.31,5			110	1.700	6.600	12.000	21	17					
			40	30 002 13.40			140	2.900	12.000	19.000	27	13					
			50	30 002 13.50			170	5.700	20.000	33.000	30	9,3					
			63	30 010 13.63			210	10.700	40.000	66.000	38	6,8					
			67	80			30 010 13.80	280	21.000	78.000	140.000	47	4,8				
				100			30 010 13.100	320	33.000	130.000	210.000	60	3,8				
				125			30 010 13.125	390	47.000	180.000	390.000	98	3,3				
				160			30 018 13.160	600	90.000	330.000	570.000	124	2,5				
				200 RC140			30 018 14.200	800	225.000	540.000	920.000	60	2,1				
			250 RC160	30 018 14.250			1.000	265.000	660.000	1.100.000	70	1,9					
			3 / 7,2	292			53	0,5	30 098 11.0,5	1,6	63	5	1,6	3,2	5,9	3,6	13.250
								1	30 098 11.1			8	0,63	1,8	2,8	2,8	2.100
								2	30 098 12.2			16	3,2	9,8	12	5,0	935
								2,5	30 098 12.2,5			20	7,2	14,5	22	5,2	630
								3,15	30 098 13.3,15			24	17	32	48	5,5	420
								4	30 098 13.4			32	31	62	90	7,2	310
								5	30 098 13.5			40	40	80	125	5,0	141
								6,3	30 098 13.6,3			22	45	210	360	10	178
								10	30 098 13.10			34	75	350	560	17	113
								16	30 098 13.16			56	250	1.100	2.000	17	50
								20	30 098 13.20			70	640	2.900	4.800	13	27
								25	30 098 13.25			90	1.050	4.700	7.500	16	21
								31,5	30 098 13.31,5			110	1.700	6.600	12.000	21	17
40	30 098 13.40	140			2.900	12.000		19.000	27			13					
50	30 098 13.50	170			5.700	20.000		33.000	30			9,3					
63	30 099 13.63	210			10.700	40.000		66.000	34			6,8					
67	80	30 099 13.80			280	21.000		78.000	140.000			47	4,8				
	100	30 099 13.100			320	33.000		130.000	210.000			58	3,8				
	125	30 099 13.125			390	47.000		180.000	390.000			98	3,3				
	160	30 100 13.160			600	90.000		330.000	570.000			103	2,5				
	200 RC160	30 100 14.200			800	230.000		480.000	704.000			74	2,1				
250 RC180	30 100 14.250	1.000			371.000	750.000		1.100.000	77			1,7					
315 RC200	30 100 14.315	1.260			545.000	1.060.000		1.616.000	81			1,4					
355 RC225	30 100 14.355	1.420			825.000	1.420.000		2.225.000	89			1,2					

Lote 1 unidad / Packing 1 piece

* RC Corriente nominal (ver página 35) / * RC=Rated Current (see page 35)

Fusibles de acompañamiento de media tensión HV – Back-Up fuse links



HHD-B

3 / 7,2 kV

Tensión Nominal Rated Voltage	Dimensiones Dimensions		Intensidad Nominal Rated Current	Referencia Reference	Peso Weight	Poder de Corte Rated Breaking Current I_1	Intensidad Mínima Fusión Min. Breaking Current I_3	Prearco Pre-Arcing I^2t	I^2t Total Total I^2t -Value		Pérdidas Power Loss	Resistencia en frío Cold Resistance	
	Longitud Length "e"	ØD							$U_{n\ min}$	$U_{n\ max}$			
kV	mm	mm	A		kg/1	kA	A	A ² s	A ² s	A ² s	W	mΩ	
3 / 7,2	442	53	0,5	30 108 11.0,5	2,1	63	5	1,6	3,2	5,9	3,6	13.250	
			1	30 108 11.1			8	0,63	1,8	2,8	2,8	2.100	
			2	30 108 13.2			16	3,2	9,8	12	5,0	935	
			2,5	30 108 13.2,5			20	7,2	14,5	22	5,2	630	
			3,15	30 108 13.3,15			24	17	32	48	5,5	420	
			4	30 108 13.4			32	31	62	90	7,2	310	
			5	30 108 13.5			40	40	80	125	5,0	141	
			6,3	30 108 13.6,3			22	45	210	360	10	178	
			10	30 108 13.10			34	75	350	560	17	113	
			16	30 108 13.16			56	250	1.100	2.000	11	50	
			20	30 108 13.20			70	640	2.900	4.800	13	27	
			25	30 108 13.25			90	1.050	4.700	7.500	16	21	
			31,5	30 108 13.31,5			110	1.700	6.600	12.000	21	17	
			40	30 108 13.40			140	2.900	12.000	19.000	27	13	
		50	30 108 13.50	170	5.700	20.000	33.000	30	9,3				
		67	67	63	30 109 13.63	2,9	50	210	10.700	40.000	66.000	34	6,8
				80	30 109 13.80			280	21.000	78.000	140.000	47	4,8
				100	30 109 13.100			320	33.000	130.000	210.000	58	3,8
				125	30 109 13.125			390	47.000	180.000	390.000	85	3,3
				160	30 110 13.160			600	90.000	330.000	570.000	98	2,3
				200	30 110 14.200			800	230.000	480.000	704.000	121	2,1
		85	85	250 RC225	30 110 14.250	5,4	50	1.000	371.000	750.000	1.100.000	145	1,7
				315 RC250	30 110 14.315			1.260	545.000	1.060.000	1.616.000	143	1,4
				355 RC250	30 110 14.355			1.420	825.000	1.420.000	2.225.000	154	1,2
				400 RC315	30 110 14.400			1.600	1.000.000	1.900.000	2.528.000	165	1,1
				500 RC355	30 110 14.500			2.000	1.668.000	3.160.000	4.500.000	176	0,85

* RC Corriente nominal (ver página 35) / * RC=Rated Current (see page 35)

Lote 1 unidad / Packing 1 piece

Fusibles de acompañamiento de media tensión HV – Back-Up fuse links

Gama / Range



HHD-B

6 / 12 kV

Tensión Nominal Rated Voltage	Dimensiones Dimensions		Intensidad Nominal Rated Current	Referencia Reference	Peso Weight	Poder de Corte Rated Breaking Current I_1	Intensidad Mínima Fusión Min. Breaking Current I_3	Prearco Pre-Arcing I^2t	I^2t Total Total I^2t -Value		Pérdidas Power Loss	Resistencia en frío Cold Resistance		
	Longitud Length "e"	Ø D							U_n min	U_n max				
kV	mm	mm	A		kg/1	kA	A	A ² s	A ² s	A ² s	W	m Ω		
6/12	192	53	0,5	30 119 11.0,5	1,2	63	5	1,6	3,2	5,9	6,1	22.130		
			1	30 119 11.1			8	0,63	1,8	2,8	4,8	3.510		
			2	30 119 13.2			16	3,2	9,8	12	8,2	1.570		
			2,5	30 119 13.2,5			20	7,2	14,5	22	8,9	950		
			3,15	30 119 13.3,15			24	17	32	48	9,6	700		
			4	30 119 13.4			32	31	62	90	12	520		
			5	30 119 13.5			40	40	80	125	8,3	236		
			6,3	30 119 13.6,3			22	45	210	360	16	297		
			10	30 119 13.10			34	75	350	560	28	189		
		16	30 119 13.16	56	250	1.100	2.000	28	87					
		67	20	30 267 13.20	70	640	2.900	4.800	23	46				
			25	30 267 13.25	90	1.050	4.700	7.500	29	36				
			31,5	30 267 13.31,5	110	1.700	6.600	12.000	38	29				
			40	30 267 13.40	140	2.900	12.000	19.000	50	22				
			50	30 267 13.50	170	5.700	20.000	33.000	56	16				
			63	30 267 13.63	210	10.700	40.000	66.000	63	12				
			292	53	0,5	30 004 11.0,5	1,6	63	5	1,6	3,2	5,9	6,1	22.130
					1	30 004 11.1			8	0,63	1,8	2,8	4,8	3.510
	2				30 004 13.2	16			3,2	9,8	12	8,2	1.570	
	2,5	30 004 13.2,5			20	7,2			14,5	22	8,9	950		
	3,15	30 004 13.3,15			24	17			32	48	9,6	700		
	4	30 004 13.4			32	31			62	90	12	520		
	5	30 004 13.5			40	40			80	125	8,3	236		
	6,3	30 004 13.6,3			22	45			210	360	16	297		
	10	30 004 13.10			34	75			350	560	28	189		
	Medida estándar Standard dimension	16		30 004 13.16	56	250	1.100	2.000	28	84				
		20		30 004 13.20	70	640	2.900	4.800	23	45				
		25		30 004 13.25	90	1.050	4.700	7.500	29	34				
		31,5		30 004 13.31,5	110	1.700	6.600	12.000	38	28				
		40		30 004 13.40	140	2.900	12.000	19.000	50	22				
		50		30 004 13.50	170	5.700	20.000	33.000	56	16				
	67	63	30 012 13.63	210	10.700	40.000	66.000	63	12					
		80	30 012 13.80	280	21.000	64.000	140.000	76	8,5					
100		30 012 13.100	320	28.000	97.000	210.000	104	6,5						
125		30 012 13.125	390	38.000	138.000	300.000	159	5,5						
160 RC125		30 020 13.160	600	78.000	350.000	615.000	96	4,2						
200 RC125		30 020 14.200	800	227.000	465.000	800.000	91	3,6						
85	250 RC140	30 020 14.250	3,8	50	1.000	265.000	540.000	930.000	92	3,2				

Lote 1 unidad / Packing 1 piece

* RC Corriente nominal (ver página 36) / * RC=Rated Current (see page 36)

Fusibles de acompañamiento de media tensión HV – Back-Up fuse links



HHD-B

6 / 12 kV

Tensión Nominal Rated Voltage	Dimensiones Dimensions		Intensidad Nominal Rated Current	Referencia Reference	Peso Weight	Poder de Corte Rated Breaking Current I_1	Intensidad Mínima Fusión Min. Breaking Current I_3	Prearco Pre-Arcing I^2t	I^2t Total Total I^2t -Value		Pérdidas Power Loss	Resistencia en frío Cold Resistance
	Longitud Length "e"	Ø D							U_n min	U_n max		
kV	mm	mm	A		kg/1	kA	A	A ² s	A ² s	A ² s	W	mΩ
6/12	442	53	0,5	30 101 11.0,5	2,2	63	5	1,6	3,2	5,9	6,1	22.130
			1	30 101 11.1			8	0,63	1,8	2,8	4,8	3.510
			2	30 101 13.2			16	3,2	9,8	12	8,2	1.570
			2,5	30 101 13.2,5			20	7,2	14,5	22	8,9	950
			3,15	30 101 13.3,15			24	17	32	48	9,6	700
			4	30 101 13.4			32	31	62	90	12	520
			5	30 101 13.5			40	40	80	125	8,3	236
			6,3	30 101 13.6,3			22	45	210	360	16	297
			10	30 101 13.10			34	75	350	560	28	189
			16	30 101 13.16			56	250	1.100	2.000	19	87
			20	30 101 13.20			70	640	2.900	4.800	22	46
			25	30 101 13.25			90	1.050	4.700	7.500	28	36
			31,5	30 101 13.31,5			110	1.700	6.600	12.000	37	29
			40	30 101 13.40			140	2.900	12.000	19.000	48	22
		50	30 101 13.50	170	5.700	20.000	33.000	54	16			
		63	30 102 13.63	210	10.700	40.000	66.000	58	12			
		80	30 102 13.80	280	21.000	64.000	140.000	70	8,5			
		100	30 102 13.100	320	28.000	97.000	210.000	96	6,5			
		125	30 102 13.125	390	38.000	133.000	300.000	127	5,5			
		160	30 103 13.160	600	78.000	350.000	615.000	172	4,1			
		200 RC180	30 103 14.200	800	310.000	630.000	1.200.000	134	3,0			
		250 RC200	30 103 14.250	1.000	405.000	850.000	1.500.000	139	2,6			
		100	30 211 13.100	320	33.000	130.000	210.000	96	6,5			
		125	30 211 13.125	390	47.000	180.000	390.000	147	5,5			
		160	30 211 13.160	600	78.000	350.000	615.000	172	3,9			
		200 RC180	30 211 14.200	800	310.000	630.000	1.200.000	163	3,0			
		250 RC212	30 211 14.250	1.000	405.000	850.000	1.500.000	185	2,6			
		315 RC225	30 211 14.315	1.260	580.000	1.100.000	2.000.000	187	2,2			

* RC Corriente nominal (ver página 36) / * RC=Rated Current (see page 36)

Lote 1 unidad / Packing 1 piece

Fusibles de acompañamiento de media tensión HV – Back-Up fuse links

10 / 17,5 kV

Gama / Range



HHD-B

10 / 17,5 kV

Tensión Nominal Rated Voltage	Dimensiones Dimensions		Intensidad Nominal Rated Current	Referencia Reference	Peso Weight	Poder de Corte Rated Breaking Current I_b	Intensidad Mínima Fusión Min. Breaking Current I_3	Prearco Pre-Arcing I^2t	I^2t Total Total I^2t -Value		Pérdidas Power Loss	Resistencia en frío Cold Resistance	
	Longitud Length "e"	Ø D							U_n min	U_n max			
kV	mm	mm	A		kg/1	kA	A	A ² s	A ² s	A ² s	W	m Ω	
10/17,5	192	53	0,5	30 179 11.0,5	1,2	63	5	1,6	3,2	5,9	8,1	29.480	
			1	30 179 11.1			8	0,63	1,2	1,8	6,2	4.640	
			2	30 179 13.2			16	3,2	6,5	9,8	11	2.060	
			2,5	30 179 13.2,5			20	7,2	17	24	12	1.400	
			3,15	30 179 13.3,15			24	17	32	48	13	920	
			4	30 179 13.4			32	31	62	90	16	690	
			5	30 179 13.5			40	40	80	125	11	314	
			6,3	30 179 13.6,3			22	45	210	360	21	397	
			10	30 179 13.10			34	75	350	560	38	252	
			0,5	30 255 11.0,5			53	0,5	30 255 11.0,5	1,6	5	1,6	3,2
	1	30 255 11.1	8	0,63	1,8			2,8	6,2		4.640		
	2	30 255 13.2	16	3,2	9,8			12	11		2.060		
	2,5	30 255 13.2,5	20	7,2	14,5			22	12		1.400		
	3,15	30 255 13.3,15	24	17	32			48	13		920		
	4	30 255 13.4	32	31	62			90	16		690		
	5	30 255 13.5	40	40	80			125	11		314		
	6,3	30 255 13.6,3	22	45	210			360	21		397		
	10	30 255 13.10	34	75	350			560	38		252		
	16	30 255 13.16	56	250	1.100			2.000	37		116		
	292	67	53	20	30 221 13.20		2,0	70	640	2.900	4.800	40	62
				25	30 221 13.25			90	1.050	4.700	7.500	56	48
				31,5	30 221 13.31,5			110	1.700	6.600	12.000	65	39
				40	30 221 13.40			140	2.900	12.000	19.000	84	29
				50	30 221 13.50			170	5.700	20.000	33.000	101	21
				63	30 221 13.63			210	10.700	40.000	66.000	106	16
				80	30 222 13.80			280	17.500	74.000	155.000	137	11
				100	30 222 13.100			320	28.000	120.000	250.000	165	8,5
				125	30 222 13.125			390	38.000	160.000	337.000	235	7,3
				160 RC100	30 222 13.160			600	42.000	173.000	375.000	96	6,6

* RC Corriente nominal (ver página 37) / * RC=Rated Current (see page 37)

Fusibles de acompañamiento de media tensión HV – Back-Up fuse links



HHD-B

10 / 17,5 kV

Tensión Nominal Rated Voltage	Dimensiones Dimensions		Intensidad Nominal Rated Current	Referencia Reference	Peso Weight	Poder de Corte Rated Breaking Current I_1	Intensidad Mínima Fusión Min. Breaking Current I_3	Prearco Pre-Arcing I^t	I ^t Total Total I ^t -Value		Pérdidas Power Loss	Resistencia en frío Cold Resistance		
	Longitud Length "e"	Ø D							U _n min	U _n max				
kV	mm	mm	A		kg/1	kA	A	A ² s	A ² s	A ² s	W	mΩ		
10/17,5	367	53	0,5	30 176 11.0,5	2,0	63	5	1,6	3,2	5,9	8,1	29.480		
			1	30 176 11.1			8	0,63	1,8	2,8	6,2	4.640		
			2	30 176 13.2			16	3,2	9,8	12	11	2.060		
			2,5	30 176 13.2,5			20	7,2	14,5	22	12	1.400		
			3,15	30 176 13.3,15			24	17	32	48	13	920		
			4	30 176 13.4			32	31	62	90	16	690		
			5	30 176 13.5			40	40	80	125	11	314		
			6,3	30 176 13.6,3			22	45	210	360	21	397		
			10	30 176 13.10			34	75	350	560	38	252		
			16	30 176 13.16			56	250	1.100	2.000	37	116		
			20	30 176 13.20			70	640	2.900	4.800	40	62		
			25	30 176 13.25			90	1.050	4.700	7.500	56	48		
			31,5	30 177 13.31,5			110	1.700	6.600	12.000	65	39		
			40	30 177 13.40			140	2.900	12.000	19.000	84	29		
			50	30 177 13.50			170	5.700	20.000	33.000	101	21		
		63	30 177 13.63	210	10.700	40.000	66.000	106	16					
		80	30 178 13.80	280	17.500	74.000	135.000	137	11					
		100	30 178 13.100	320	28.000	134.000	215.000	157	8,5					
		125	30 178 13.125	390	47.000	225.000	360.000	190	6,6					
		160 RC112	30 178 13.160	600	62.000	290.000	475.000	116	6,4					
		200 RC125	30 178 14.200	800	78.000	360.000	595.000	118	5,2					
		10/17,5	442	53	0,5	30 231 11.0,5	2,2	63	5	1,6	3,2	5,9	8,1	29.480
					1	30 231 11.1			8	0,63	1,8	2,8	6,2	4.640
					2	30 231 13.2			16	3,2	9,8	12	11	2.060
					2,5	30 231 13.2,5			20	7,2	14,5	22	12	1.400
					3,15	30 231 13.3,15			24	17	32	48	13	920
					4	30 231 13.4			32	31	62	90	16	690
					5	30 231 13.5			40	40	80	125	11	314
					6,3	30 231 13.6,3			22	45	210	360	21	397
					10	30 231 13.10			34	75	350	560	38	252
16	30 231 13.16				56	250			1.100	2.000	37	116		
20	30 231 13.20				70	640			2.900	4.800	42	62		
25	30 231 13.25				90	1.050			4.700	7.500	56	48		
31,5	30 231 13.31,5				110	1.700			6.600	12.000	69	39		
40	30 231 13.40				140	2.900			12.000	19.000	84	29		
50	30 232 13.50				170	5.700			20.000	33.000	101	21		
63	30 232 13.63			210	10.700	40.000	66.000	106	16					
80	30 232 13.80			280	17.500	74.000	135.000	137	11					
100	30 233 13.100			320	28.000	134.000	215.000	182	8,7					
125	30 233 13.125			390	47.000	225.000	360.000	229	7,5					
160 RC125	30 233 13.160			600	62.000	290.000	475.000	142	6,4					
200 RC140	20 233 14.200			800	78.000	360.000	595.000	148	5,2					

* RC Corriente nominal (ver página 37) / * RC=Rated Current (see page 37)

Lote 1 unidad / Packing 1 piece

Fusibles de acompañamiento de media tensión HV – Back-Up fuse links

Gama / Range



HHD-B

10 / 24 kV

Tensión Nominal Rated Voltage	Dimensiones Dimensions		Intensidad Nominal Rated Current	Referencia Reference	Peso Weight	Poder de Corte Rated Breaking Current I_b	Intensidad Mínima Fusión Min. Breaking Current I_3	Prearco Pre-Arcing I^2t	I ² t Total Total I ² t-Value		Pérdidas Power Loss	Resistencia en frío Cold Resistance	
	Longitud Length "e"	Ø D							U _n min	U _n max			
kV	mm	mm	A		kg/1	kA	A	A ² s	A ² s	A ² s	W	mΩ	
10/24	292	53	0,5	30 180 11.0,5	1,6	63	5	1,6	3,2	5,9	11,2	40.550	
			1	30 180 11.1			8	0,63	1,8	2,8	8,6	6.450	
			2	30 180 13.2			16	3,2	9,8	12	15	2.850	
			2,5	30 180 13.2,5			20	7,2	14,5	22	16	1.920	
			3,15	30 180 13.3,15			24	17	32	48	18	1.300	
			4	30 180 13.4			32	31	62	90	22	950	
			5	30 180 13.5			40	40	80	125	15	433	
			6,3	30 180 13.6,3			22	45	210	360	29	546	
			10	30 180 13.10			34	75	350	560	52	347	
			16	30 180 13.16			56	250	1.100	2.000	59	160	
			20	30 225 13.20			70	640	2.900	4.800	46	86	
			25	30 225 13.25			90	1.050	4.700	7.500	56	66	
			31,5	30 225 13.31,5			110	1.700	6.600	12.000	72	53	
			40	30 225 13.40			160	2.900	12.000	19.000	106	43	
	50 RC45	30 225 13.50	215	4.900	21.000	34.000	108	32					
	63 RC50	30 225 13.63	285	8.700	38.000	61.000	115	24					
	Medida estándar Standard dimension	442	53	0,5	30 006 11.0,5	2,2	63	5	1,6	3,2	5,9	11,2	40.550
				1	30 006 11.1			8	0,63	1,8	2,8	8,6	6.450
				2	30 006 13.2			16	3,2	9,8	12	15	2.850
				2,5	30 006 13.2,5			20	7,2	14,5	22	16	1.920
				3,15	30 006 13.3,15			24	17	32	48	18	1.300
				4	30 006 13.4			32	31	62	90	22	950
				5	30 006 13.5			40	40	80	125	15	433
				6,3	30 006 13.6,3			22	45	210	360	29	546
				10	30 006 13.10			34	75	350	560	52	347
				16	30 006 13.16			56	250	1.100	2.000	59	151
				20	30 006 13.20			70	640	2.900	4.800	46	83
				25	30 006 13.25			90	1.050	4.700	7.500	56	62
31,5				30 006 13.31,5	110			1.700	6.600	12.000	72	52	
40				30 006 13.40	140			2.900	12.000	19.000	106	43	
50	30 014 13.50	170	5.700	20.000	33.000	108	29						
63	30 014 13.63	210	10.700	40.000	66.000	132	22						
80	30 014 13.80	280	21.000	78.000	140.000	174	16						
100	30 022 13.100	320	28.000	160.000	255.000	234	13						
125	30 022 13.125	390	47.000	180.000	300.000	320	11						
160 RC100	30 022 13.160	580	62.000	237.000	281.000	156	10						
200 RC112	30 022 14.200	650	75.000	290.000	340.000	179	9						

Lote 1 unidad / Packing 1 piece

* RC Corriente nominal (ver página 38) / * RC=Rated Current (see page 38)

Fusibles de acompañamiento de media tensión HV – Back-Up fuse links



HHD-B

10 / 24 kV

Tensión Nominal Rated Voltage	Dimensiones Dimensions		Intensidad Nominal Rated Current	Referencia Reference	Peso Weight	Poder de Corte Rated Breaking Current I_1	Intensidad Mínima Fusión Min. Breaking Current I_3	Prearco Pre-Arcing I^2t	I ² t Total Total I ² t-Value		Pérdidas Power Loss	Resistencia en frío Cold Resistance		
	Longitud Length "e"	Ø D							U _n min	U _n max				
kV	mm	mm	A		kg/1	kA	A	A ² s	A ² s	A ² s	W	m Ω		
10/24	537	53	0,5	30 203 11.0,5	2,8	63	5	1,6	3,2	5,9	11,2	40.550		
			1	30 203 11.1			8	0,63	1,2	1,8	8,6	6.450		
			2	30 203 13.2			16	3,2	6,5	9,8	15	2.850		
			2,5	30 203 13.2,5			20	7,2	19	26	16	1.920		
			3,15	30 203 13.3,15			24	17	32	48	18	1.300		
			4	30 203 13.4			32	31	62	90	22	950		
			5	30 203 13.5			40	40	80	125	15	433		
			6,3	30 203 13.6,3			22	45	210	360	29	546		
			10	30 203 13.10			34	75	350	560	52	347		
			16	30 203 13.16			56	250	1.100	2.000	59	151		
		67	85	50	20	30 203 13.20	3,7	63	70	640	2.900	4.800	46	83
					25	30 203 13.25			90	1.050	4.700	7.500	56	62
				31,5	30 203 13.31,5	110			1.700	6.600	12.000	72	52	
				40	30 203 13.40	140			2.900	12.000	19.000	106	41	
				63	80	170			5.700	20.000	33.000	108	29	
						210			10.700	40.000	66.000	132	22	
				100	125	280			21.000	78.000	140.000	174	16	
						320			28.000	160.000	255.000	239	13	
				160 RC112	200 RC125	250 RC140			390	47.000	180.000	300.000	320	11
									600	62.000	227.000	395.000	178	9,0
800	75.000	290.000	470.000				179	8,0						
			1.000	175.000	675.000	1.100.000	199	6,5						

* RC Corriente nominal (ver página 38) / * RC=Rated Current (see page 38)

Lote 1 unidad / Packing 1 piece

Fusibles de acompañamiento de media tensión HV – Back-Up fuse links

20 / 36 kV

Gama / Range



HHD-B

20 / 36 kV

Tensión Nominal Rated Voltage	Dimensiones Dimensions		Intensidad Nominal Rated Current	Referencia Reference	Peso Weight	Poder de Corte Rated Breaking Current I_1	Intensidad Mínima Fusión Min. Breaking Current I_3	Prearco Pre-Arcing I^2t	I^2t Total Total I^2t -Value		Pérdidas Power Loss	Resistencia en frío Cold Resistance				
	Longitud Length "e"	Ø D							$U_{n\ min}$	$U_{n\ max}$						
kV	mm	mm	A		kg/1	kA	A	A ² s	A ² s	A ² s	W	mΩ				
20/36	292	53	0,5	30 382 11.0,5	2,0	40	5	1,6	3,2	5,9	17	60.800				
			1	30 382 11.1			8	0,63	1,8	2,8	13	9.570				
			2	30 382 13.2			16	3,2	9,8	12	23	4.260				
			2,5	30 382 13.2,5			20	7,2	14,5	22	2.600					
			3,15	30 382 13.3,15			24	17	32	48	26	1.900				
			4	30 382 13.4			32	31	62	90	33	1.420				
			5	30 382 13.5			40	40	80	125	23	650				
			6,3	30 454 11.6,3			22	27	180	300	49	819				
		10	30 454 11.10	34			68	470	740	87	521					
		16	30 454 11.16	56			140	850	1.500	83	254					
		442	53	0,5			30 181 11.0,5	2,2	40	5	1,6	3,2	5,9	17	60.800	
				1			30 181 11.1			8	0,63	1,8	2,8	13	9.570	
				2			30 181 13.2			16	3,2	9,8	12	23	4.260	
				2,5			30 181 13.2,5			20	7,2	14,5	22	2.600		
				3,15			30 181 13.3,15			24	17	32	48	26	1.900	
				4			30 181 13.4			32	31	62	90	33	1.420	
	5			30 181 13.5	40	40	80			125	23	650				
	6,3			30 181 13.6,3	22	27	180			300	46	819				
	67	67	10	30 181 13.10	2,9	20	34	68	470	740	82	521				
			16	30 181 13.16			56	140	850	1.500	78	254				
			20	30 295 13.20			70	540	3.100	5.500	69	129				
			25	30 295 13.25			90	920	5.900	9.300	91	99				
			537	53			0,5	30 008 11.0,5	2,6	40	5	1,6	3,2	5,9	17	60.800
							1	30 008 11.1			8	0,63	1,8	2,8	13	9.570
							2	30 008 13.2			16	3,2	6,5	9,8	23	4.260
							2,5	30 008 13.2,5			20	7,2	21	35	22	2.600
	3,15	30 008 13.3,15			24	17	32	48			26	1.900				
	4	30 008 13.4			32	31	62	90			33	1.420				
	5	30 008 13.5			40	40	80	125			23	650				
	6,3	30 008 13.6,3			22	27	180	300			44	819				
	10	30 008 13.10			34	68	470	740			78	521				
	16	30 008 13.16			56	140	850	1.500			101	254				
20	30 008 13.20	70			540	3.100	5.500	67			129					
25	30 008 13.25	90			920	5.900	9.300	90			99					
67	67	31,5			30 016 13.31,5	3,5	40	110			1.400	7.400	13.000	135	88	
		40			30 016 13.40			140			2.500	13.800	22.700	173	66	
		50			30 024 13.50			170			4.700	31.000	43.000	214	48	
		63			30 024 13.63			210			8.700	61.000	88.000	255	35	
85	85	80 RC63	30 024 13.80	6,0	40	280	17.000	88.000	171.000	145	23					
		100 RC71	30 024 13.100			350	18.500	67.000	107.000	162	21					

Lote 1 unidad / Packing 1 piece

* RC Corriente nominal (ver página 39) / * RC=Rated Current (see page 39)

Fusibles de acompañamiento de media tensión HV – Back-Up fuse links

Gama / Range

HHD-BSSK

6 / 12 kV



Tensión Nominal Rated Voltage	Dimensiones Dimensions		Intensidad Nominal Rated Current	Referencia Reference	Peso Weight	Poder de Corte Rated Breaking Current I_1	Intensidad Mínima Fusión Min. Breaking Current I_3	Prearco Pre-Arcing I^2t	Total I^2t Total I^2t -Value	Pérdidas Power Loss	Resistencia en frío Cold Resistance
	Longitud Length "e"	Ø D									
kV	mm	mm	A		kg/1	kA	A	A ² s	A ² s	W	mΩ
6/12	292 Medida estándar Standard dimension	67	63	30 012 43.63	2,0	63	210	9.300	74.000	62	10
			80	30 012 43.80			280	12.800	103.000	76	8,7
			100	30 012 43.100			320	22.300	138.000	98	6,5
			125	30 020 43.125			450	39.000	323.000	135	4,8
	442	67	80	30 102 43.80	2,9	63	280	12.800	103.000	72	8,7
			100	30 102 43.100			320	22.300	138.000	93	6,5
			125	30 103 43.125			450	39.000	323.000	128	4,8
		85	160 RC140	30 103 43.160	5,4		600	50.000	405.000	125	4,5

Lote 1 unidad / Packing 1 piece

10 / 24 kV

Tensión Nominal Rated Voltage	Dimensiones Dimensions		Intensidad Nominal Rated Current	Referencia Reference	Peso Weight	Poder de Corte Rated Breaking Current I_1	Intensidad Mínima Fusión Min. Breaking Current I_3	Prearco Pre-Arcing I^2t	Total I^2t Total I^2t -Value	Pérdidas Power Loss	Resistencia en frío Cold Resistance
	Longitud Length "e"	Ø D									
kV	mm	mm	A		kg/1	kA	A	A ² s	A ² s	W	mΩ
10/24	442 Medida estándar Standard dimension	67	63	30 012 43.63	2,9	63	210	9.300	74.000	117	19
			80	30 012 43.80			280	12.800	103.000	143	15
			100	30 012 43.100			320	22.300	136.000	188	12
		85	125	30 020 43.125	5,4		450	30.300	248.000	277	10
			140 RC112	30 022 43.140	400		51.000	350.000	155	8	

Lote 1 unidad / Packing 1 piece

20 / 36 kV

Tensión Nominal Rated Voltage	Dimensiones Dimensions		Intensidad Nominal Rated Current	Referencia Reference	Peso Weight	Poder de Corte Rated Breaking Current I_1	Intensidad Mínima Fusión Min. Breaking Current I_3	Prearco Pre-Arcing I^2t	Total I^2t Total I^2t -Value	Pérdidas Power Loss	Resistencia en frío Cold Resistance
	Longitud Length "e"	Ø D									
kV	mm	mm	A		kg/1	kA	A	A ² s	A ² s	W	mΩ
20/36	537 Medida estándar Standard dimension	85	50	30 0024 43.50	6,0	40	170	6.200	49.000	132	36
			63	30 024 43.63			210	9.300	74.000	189	30
			80 RC71	30 024 43.80			280	18.400	138.000	153	21

Lote 1 unidad / Packing 1 piece

Gama / Range



HHD

7,2 / 36 kV

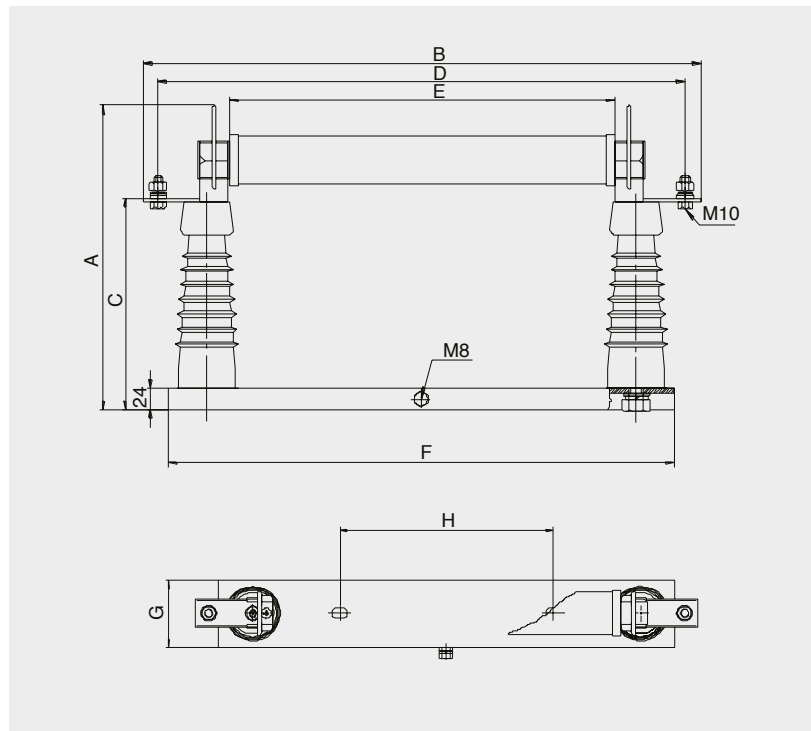
PARA INSTALACIONES INTERIORES
FOR INDOOR MOUNTING

Un (kV)	Referencia Reference
7,2	4090101
12	4090201
24	4090301
36	4090401

PARA INSTALACIONES EXTERIORES
FOR OUTDOOR MOUNTING

Un (kV)	Referencia Reference
12	4090202
24	4090302
36	4090402

	7,2	12	24	36
A	249	249	328	419
B	380	479	628	724
C	163	163	242	233
D	349	448	597	693
E	193	293	443	538
F	310	424	576	670
G	85	85	85	85
H	55	200	270	350

	12	24	36
A	371	371	371
B	480	630	725
C	283	283	283
D	450	600	695
E	293	444	538
F	412	576	678
G	85	85	85
H	200	270	350

Bases para fusibles de media tensión High Voltage fuse bases

Accesorios / Accessories



HHD

Clip	Intensidad Nominal del Fusible Fuse Rated Current
Pinza con Pletina de Conexión HV-Spring Clip Contact with Connection Bar	≤ 200 A

Clip	Intensidad Nominal del Fusible Fuse Rated Current
Aplicación interior e intemperie HV-Contact Clip for Indoor and Outdoor Application	≤ 200 A

Referencia Reference	
34 002 01	
A	35 mm
B	32 mm
F	6 mm
G	71,5 mm
H	95 mm
L	93 mm
M	M10

Referencia Reference	
31 003 02.20	
B	32 mm
G	71,5 mm
H	95 mm

Clip	Intensidad Nominal del Fusible Fuse Rated Current
Pinza con Pletina de Conexión HV-Spring Clip Contact with Connection Bar	≤ 200 A

Clip	Intensidad Nominal del Fusible Fuse Rated Current
Aplicación interior e intemperie HV-Contact Clip for Indoor and Outdoor Application	≤ 200 A

Referencia Reference	
34 001 02	
A	35 mm
B	32 mm
F	6 mm
G	73,5 mm
H	125 mm
L	93 mm
M	M10

Referencia Reference	
34 001 01.20	
B	32 mm
G	73,5 mm
H	125 mm

Referencia Reference	
34 002 01.3	
A	32 mm
B	35 mm
C	6 mm
D	10,5 mm
E	5 mm
F	18 mm
G	6,5 mm

Distanciador Spacer

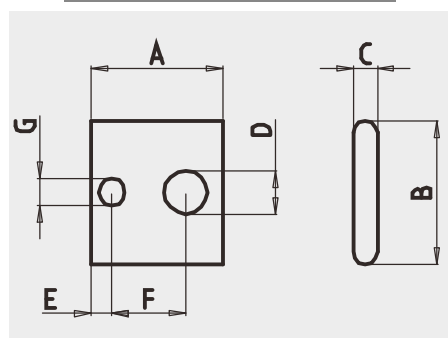

1

Bases para fusibles de media tensión High Voltage fuse bases



Adaptador 24 kV para fusibles de 12 kV 24 kV Extension Adapter for High-Voltage Fuses 12 kV

	Referencia Reference
	34 006 01
A	45 mm
B	1,5 mm
C	51 mm
D	44 mm
F	45 mm
G	5 mm
H	70 mm
L	185 mm

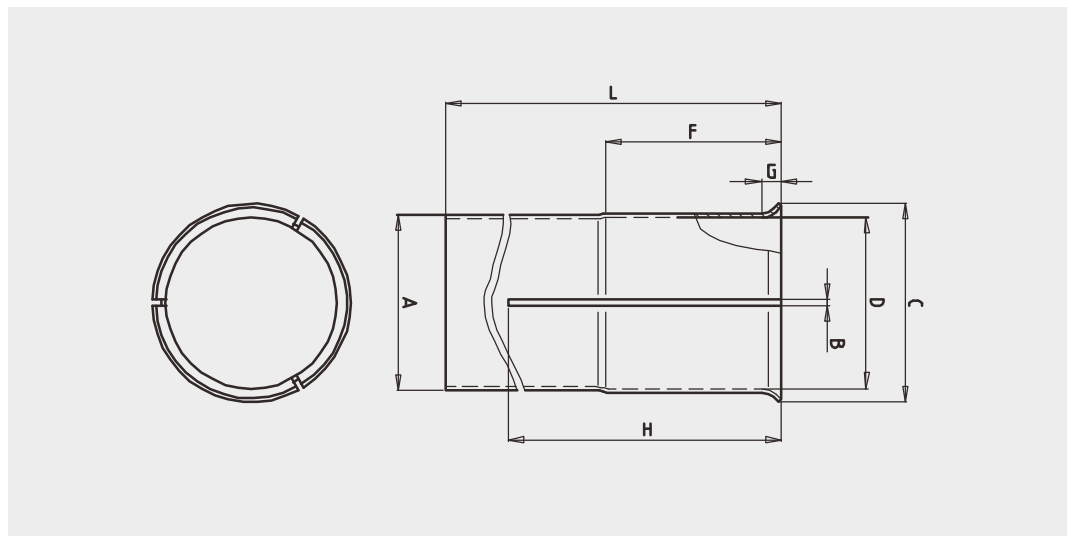

Dimensiones finales de un fusible MT 12 kV con el adaptador de 24 kV HV-Fuses with 24 kV Extension Adapter

	Referencia Reference
	34 006 02
A	45 mm
E1	292 mm
E2	442 mm
F	33 mm
L	508 mm

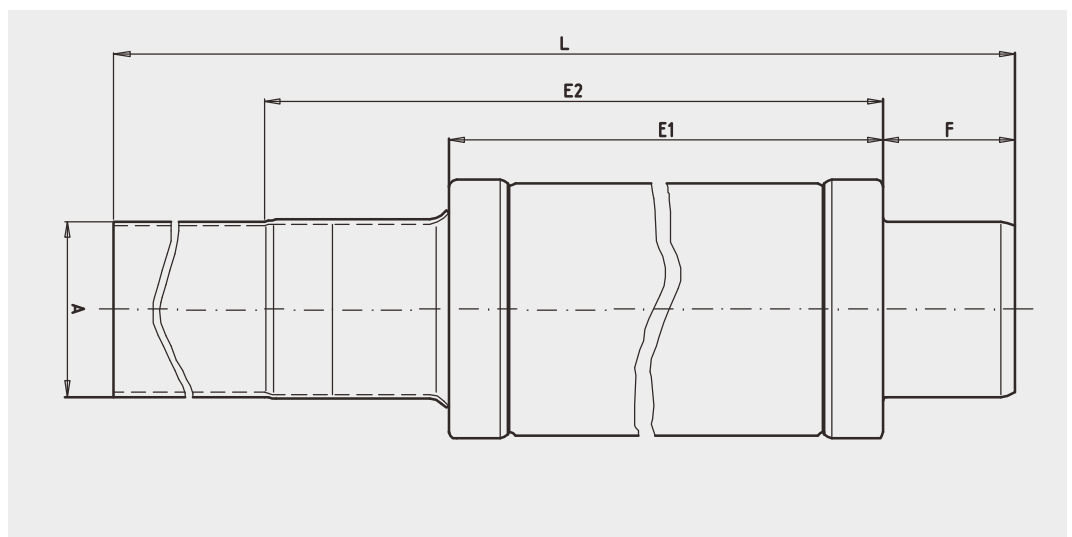

Bases para fusibles de media tensión High Voltage fuse bases



Conjunto microswitch para bases portafusibles de MT / Micro Switch Fitting to High-Voltage Fuse-Bases

L	Referencia / Reference
660 mm	31 001 10
900 mm	31 001 14
250 mm	31 001 16
1200 mm	31 001 17
Para uso inmerso en aceite / For use under oil	Referencia / Reference
660 mm	31 002 10

La instalación del conjunto microswitch (MICRORUPTOR) de SIBA para bases portafusibles de media tensión permite la supervisión del estado del fusible de MT. Por medio de un elemento flexible, el movimiento del percutor del fusible se traslada a un microswitch. El microswitch tiene un contacto variable y es compatible para 250 V AC 6A.

Los accesorios adaptadores de este conjunto están ajustados con los pernos de las bases portafusibles de MT de SIBA. Por lo tanto, cuando se añade el sistema microswitch a una base portafusibles de MT de SIBA no es necesario taladrarlo. No obstante, es posible la utilización de bases portafusibles de otros fabricantes. El conjunto puede ser fijado en el caso de que el soporte antivibraciones de contactos de SIBA Ref. 3400201 sea utilizado individualmente y no con la base portafusibles completa.

Dependiendo de la tensión de servicio del fusible de MT, el microswitch puede fijarse dentro de una distancia máxima de 660 mm desde el fusible. Es necesario tener en cuenta un radio mínimo del elemento flexible de 250 mm.

En el caso de que se utilice la pinza de contacto Ref. 3100302.20 únicamente la distancia de la pieza Ref. 3100201.3 puede ser utilizada en lugar de la pletina de conexión Ref. 3100302.2.

The SIBA microswitch installation set for high-voltage fuse-bases, allows supervision of the switching status of high-voltage fuse-links. By means of a flexible bowden drive, the movement of the fuse-link striker will be transferred to a microswitch. The microswitch itself has a change over contact and is suitable for 250 V AC, 6 A.

The fitting accessories of this installation set match with the bolting holes of SIBA high-voltage fuse-bases. Therefore, when such microswitch systems are added to SIBA high-voltage fuse-bases later on, no additional drillings have to be done. Adaption to fuses-bases of other manufacturers is, however, possible. Furthermore, the set can also be fitted if only SIBA spring clip contacts article no. 34 002 01 are used, and not a complete fuse-base.

Depending on the service voltage of the high-voltage fuse-link, the microswitch can be fitted within a maximum distance of "L" from the fuse-link. A minimum radius of the flexible bowden drive of 250 mm has to be observed.

If the panel builder only uses the spring clip contact (article no. 31 003 03.20), the spacer (article no. 31 002 01.3) must be used.

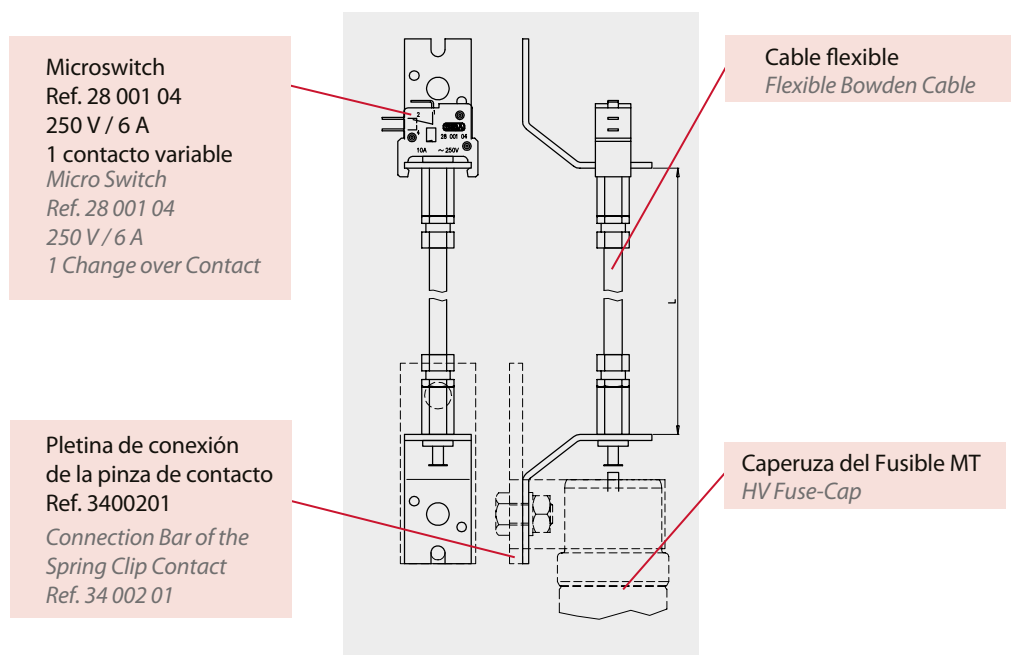

Bases para fusibles de media tensión High Voltage fuse bases



Fusible de prueba con dispositivo de retardo. Comprobación de disparo de las celdas de MT
Test-Fuse with Time Delayed Release

	Referencia Reference
	33 010 03
A	45 mm
D	70 mm
E	192 mm
F	34 mm
G	8 mm
H	27 mm
L	260 mm

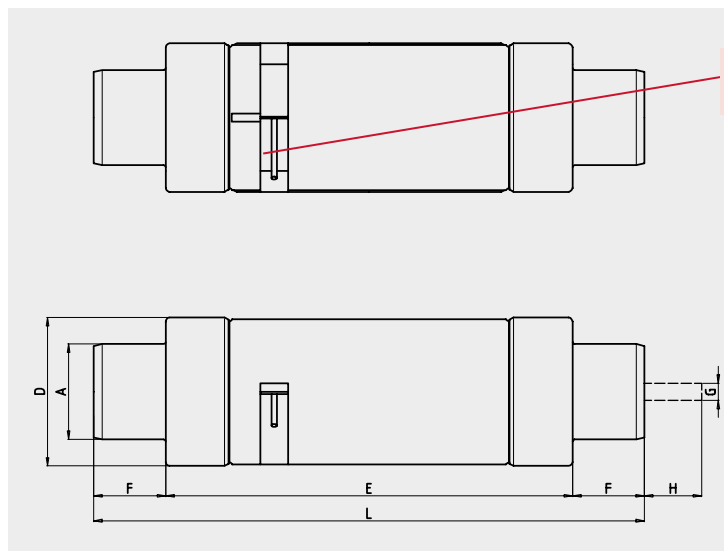

Palanca para temporizador
Clamp lever for timer

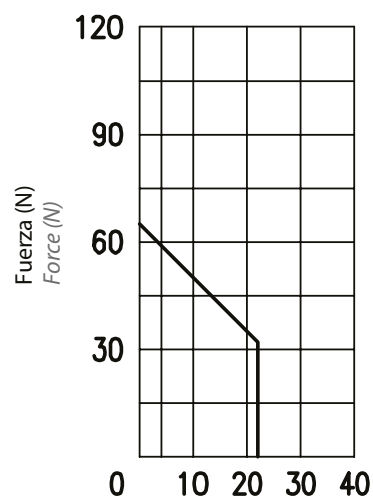

Distancia (mm)
Travel (mm)

65 N (2,5 J)

Para modificar la cota "E" existe un adaptador:
de 192 mm a 292 mm Ref. 34 004 02
de 192 mm a 442 mm Ref. 34 006 02

To change "e" an adaptor is available:
from 192 mm to 292 mm = Ref. 34 004 02
from 192 mm to 442 mm = Ref. 34 006 02



Curvas / Time current characteristics

3 / 7,2 kV

"e" = 192 mm

Característica
Tiempo-intensidad
Time-current
characteristic

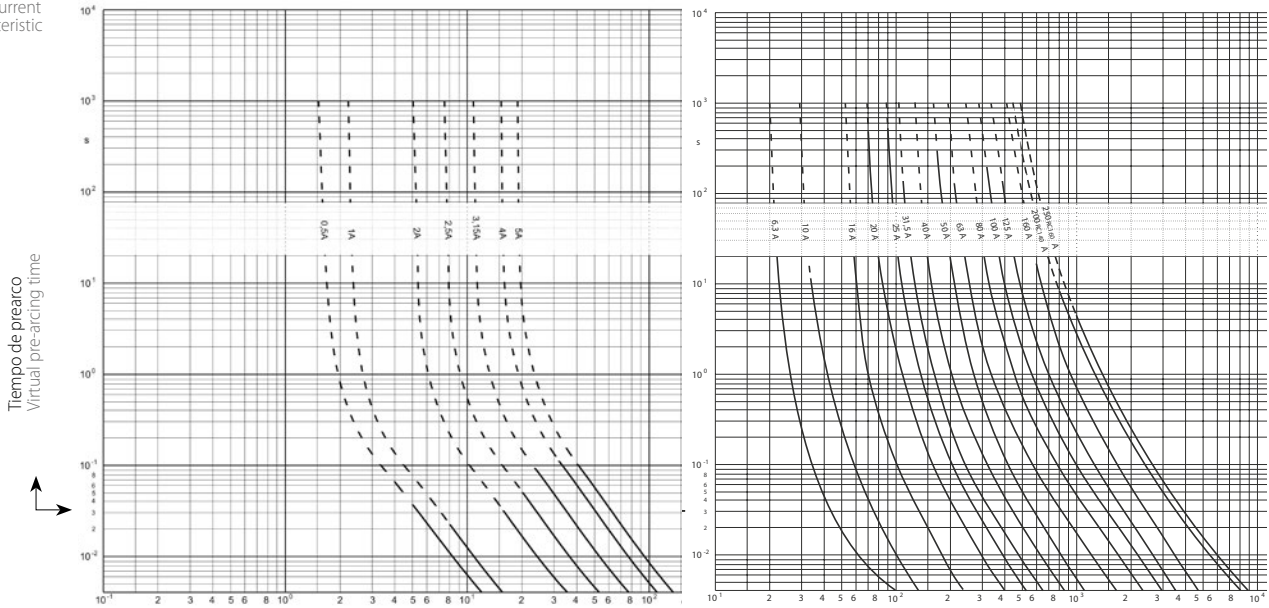

Intensidad prevista
simétrica RMS
RMS prospective current

Característica
de limitación
Cut-off current

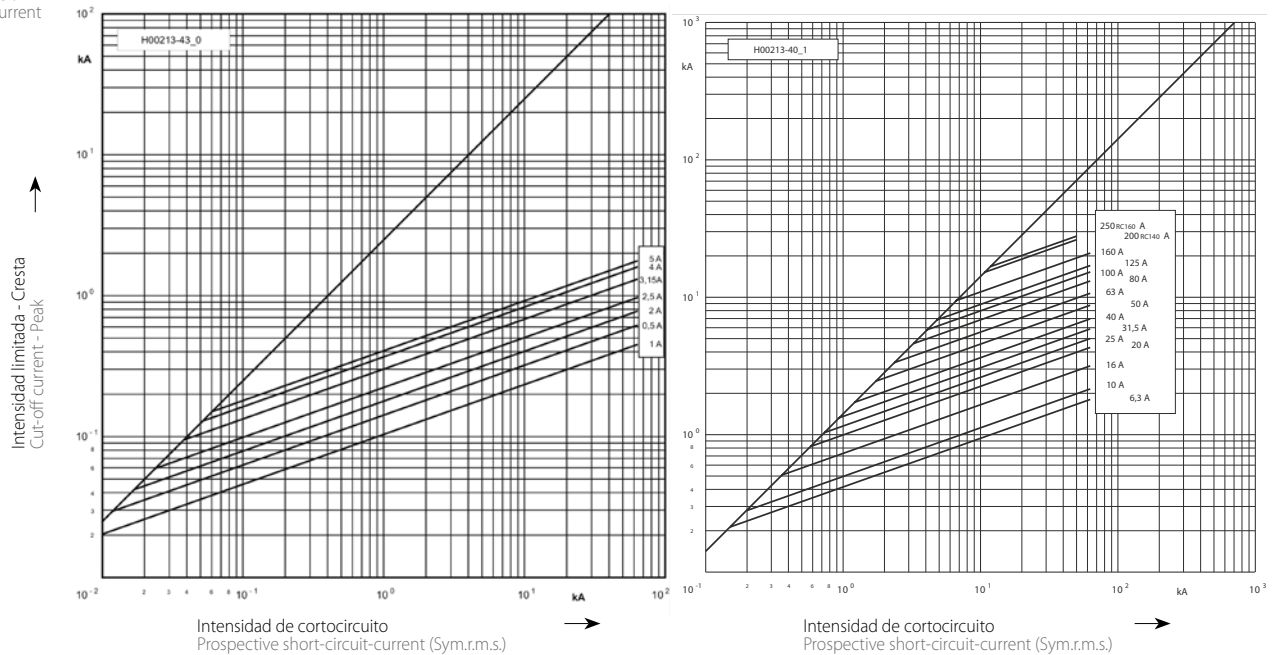

1

Fusibles de acompañamiento de media tensión
HV – Back-up fuse links

Curvas / Time current characteristics



6 / 12 kV

"e" = 292 mm

Característica
Tiempo-intensidad
Time-current
characteristic

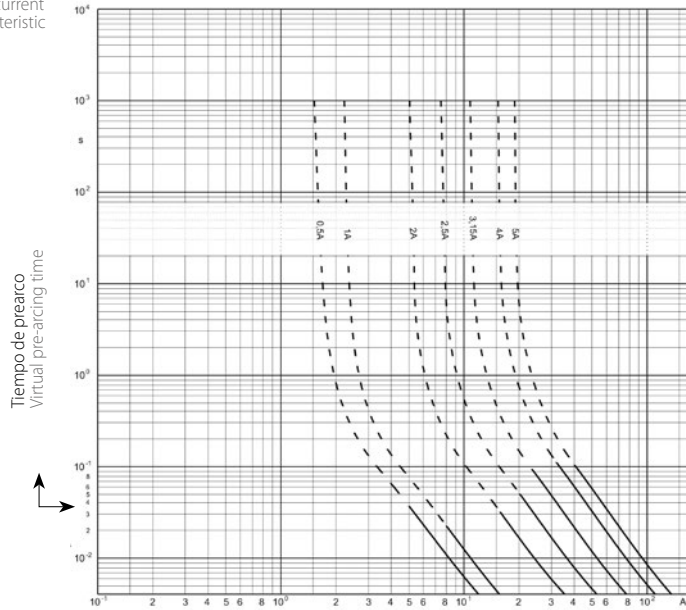

Intensidad prevista
simétrica RMS
RMS prospective current

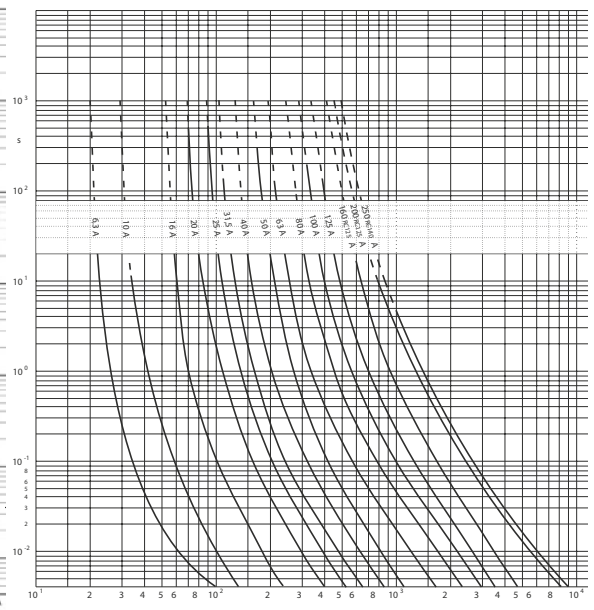

1

Característica
de limitación
Cut-off current

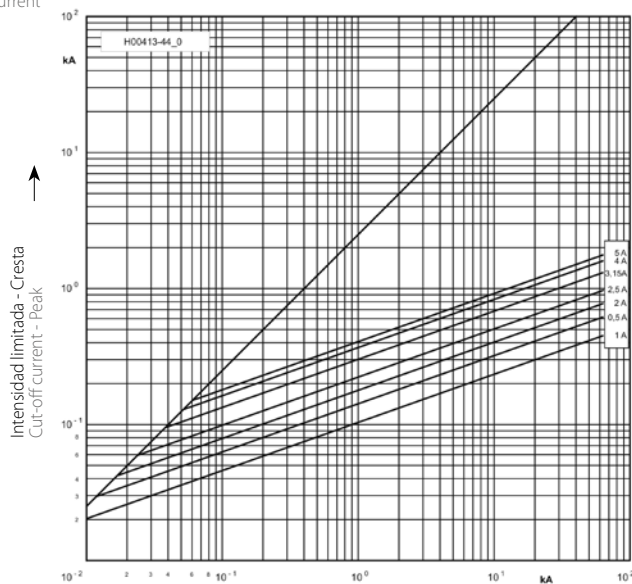

Intensidad de cortocircuito
Prospective short-circuit-current (Sym.r.m.s.)

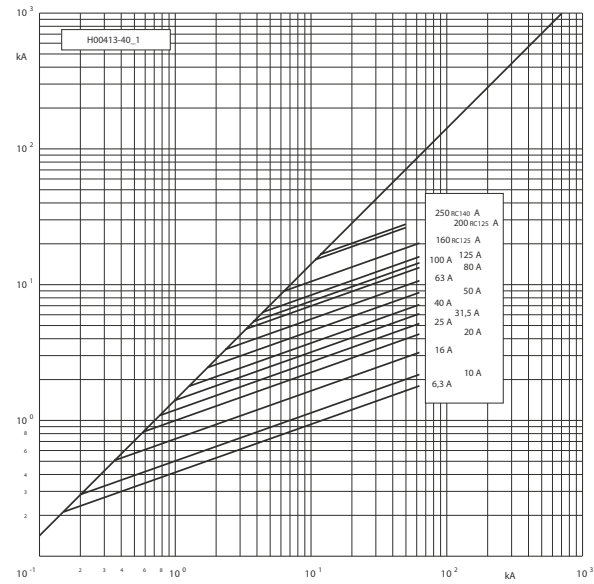

Intensidad de cortocircuito
Prospective short-circuit-current (Sym.r.m.s.)



Curvas / Time current characteristics

10 / 17,5 kV "e" = 367 mm

Característica
Tiempo-intensidad
Time-current
characteristic

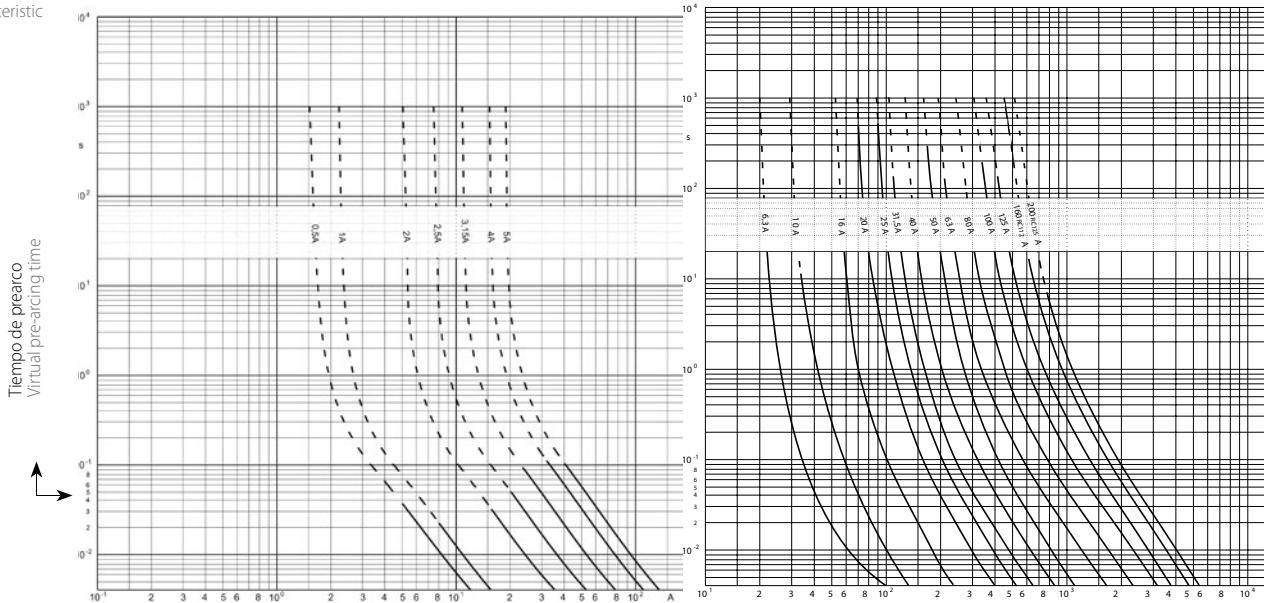

Intensidad prevista
simétrica RMS
RMS prospective current

Característica
de limitación
Cut-off current

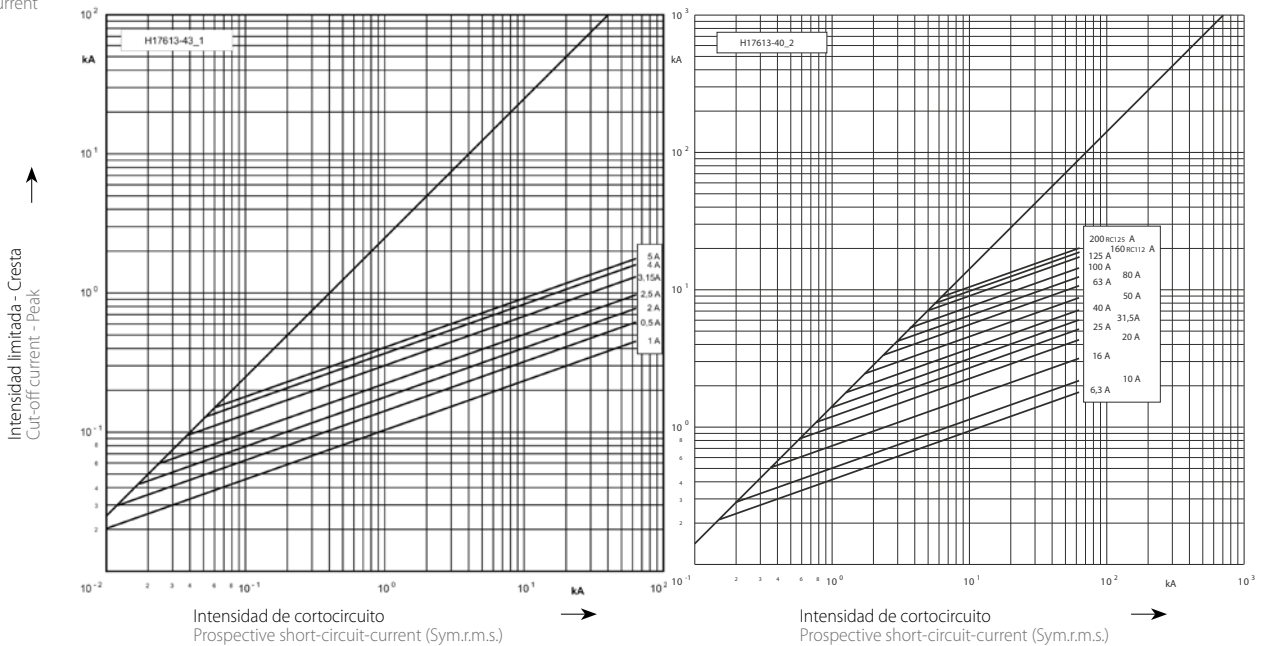

Intensidad de cortocircuito
Prospective short-circuit-current (Sym.r.m.s.)

Intensidad de cortocircuito
Prospective short-circuit-current (Sym.r.m.s.)

1

Fusibles de acompañamiento de media tensión
HV – Back-up fuse links

Curvas / Time current characteristics



10 / 24 kV "e" = 442 mm

Característica
Tiempo-intensidad
Time-current
characteristic

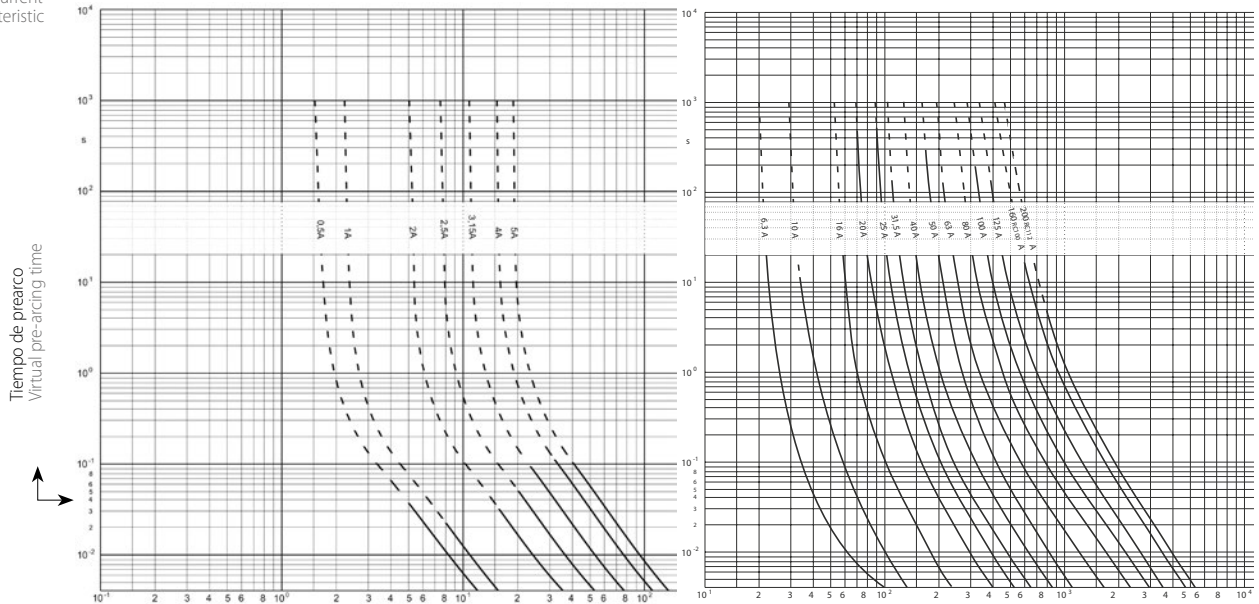

Intensidad prevista
simétrica RMS
RMS prospective current

Característica
de limitación
Cut-off current

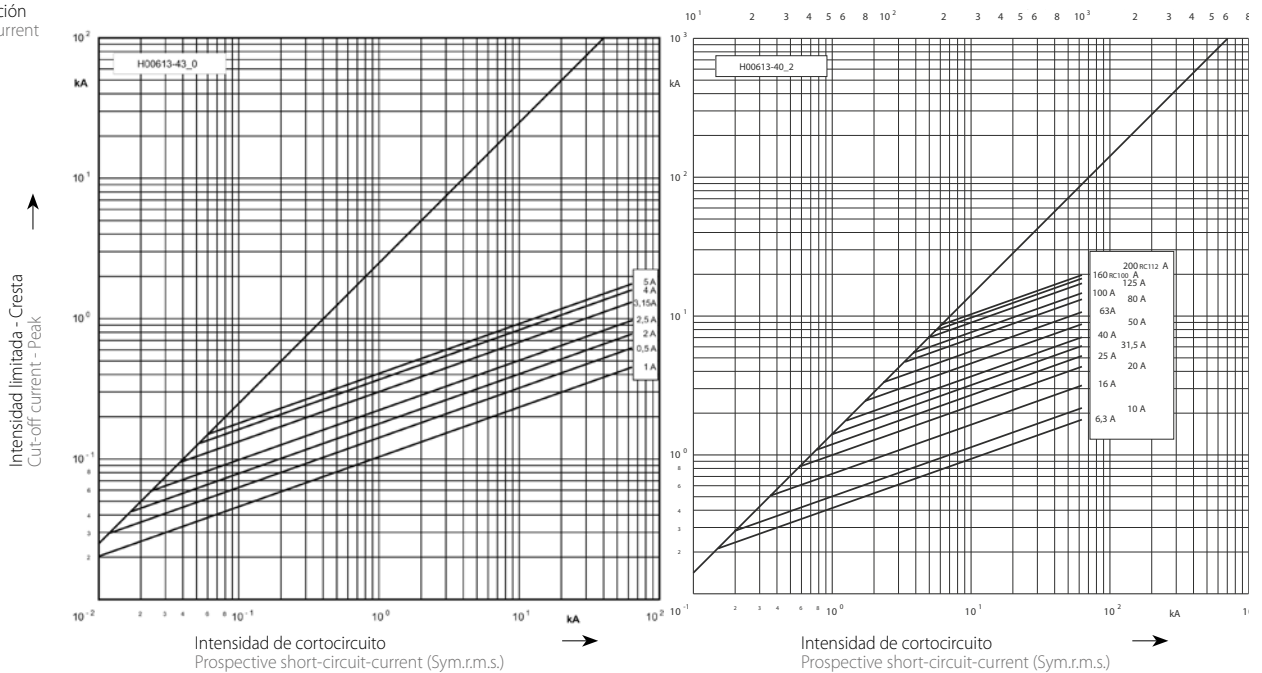

1

Fusibles de acompañamiento de media tensión HV – Back-up fuse links



Curvas / Time current characteristics

20 / 36 kV

"e" = 537 mm

Característica
Tiempo-intensidad
Time-current
characteristic

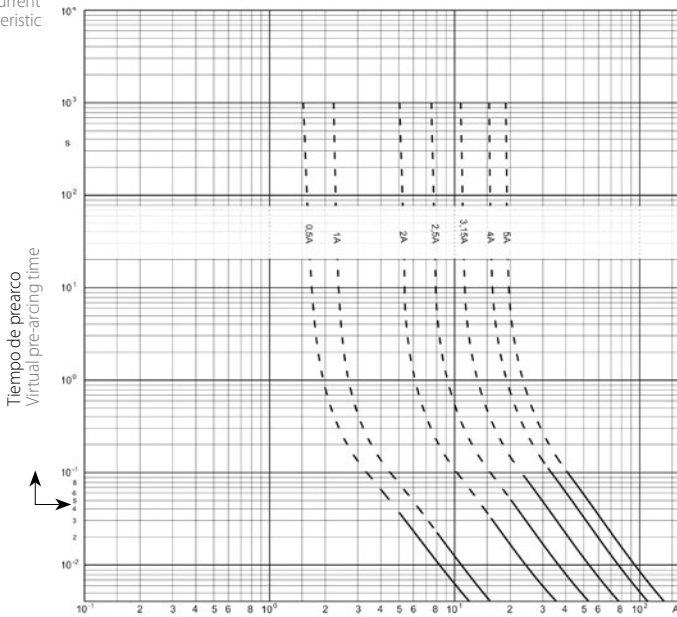

Intensidad prevista
simétrica RMS
RMS prospective current

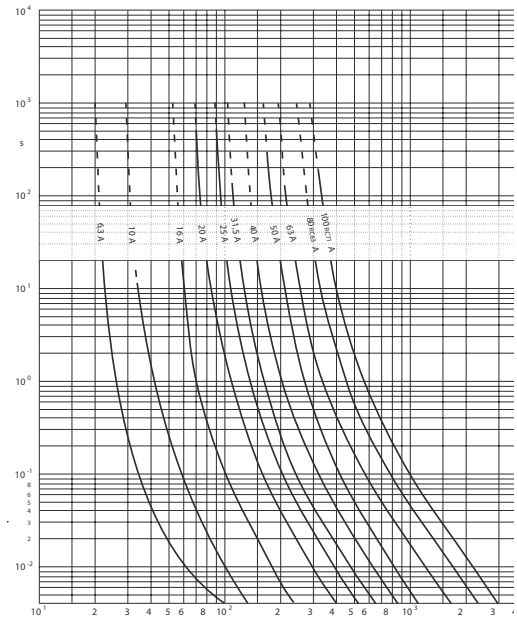

Característica
de limitación
Cut-off current

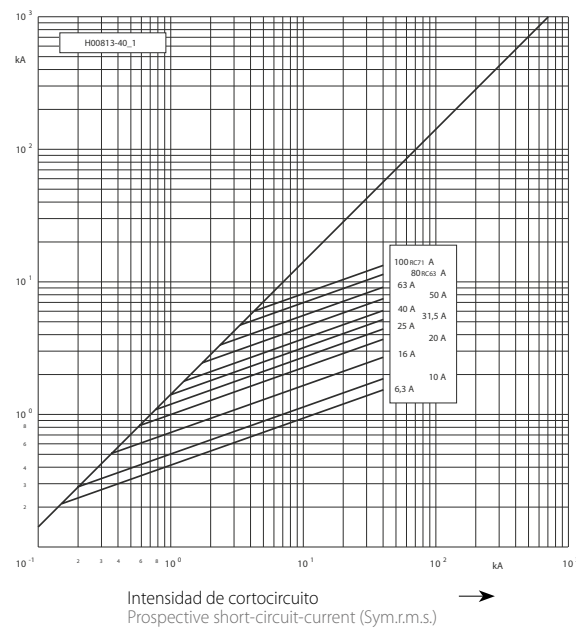
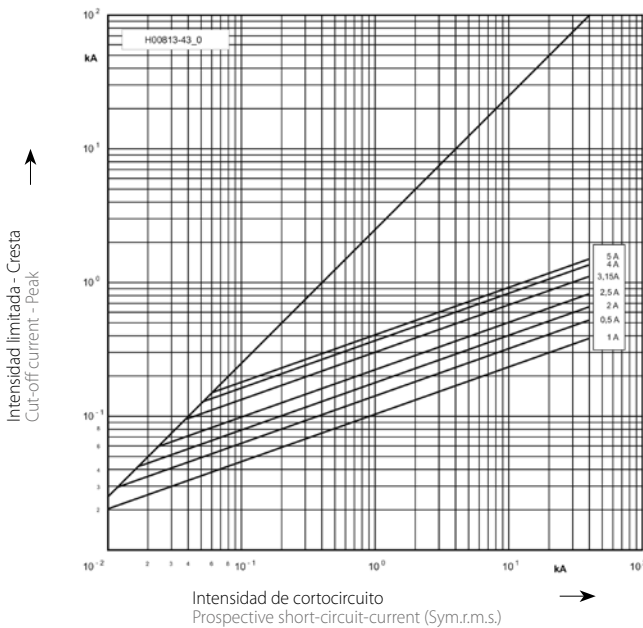

1

Fusibles de acompañamiento de media tensión
HV – Back-up fuse links

Curvas / Time current characteristics



6 / 12 kV

"e" = 292 mm

Característica
Tiempo-intensidad
Time-current
characteristic

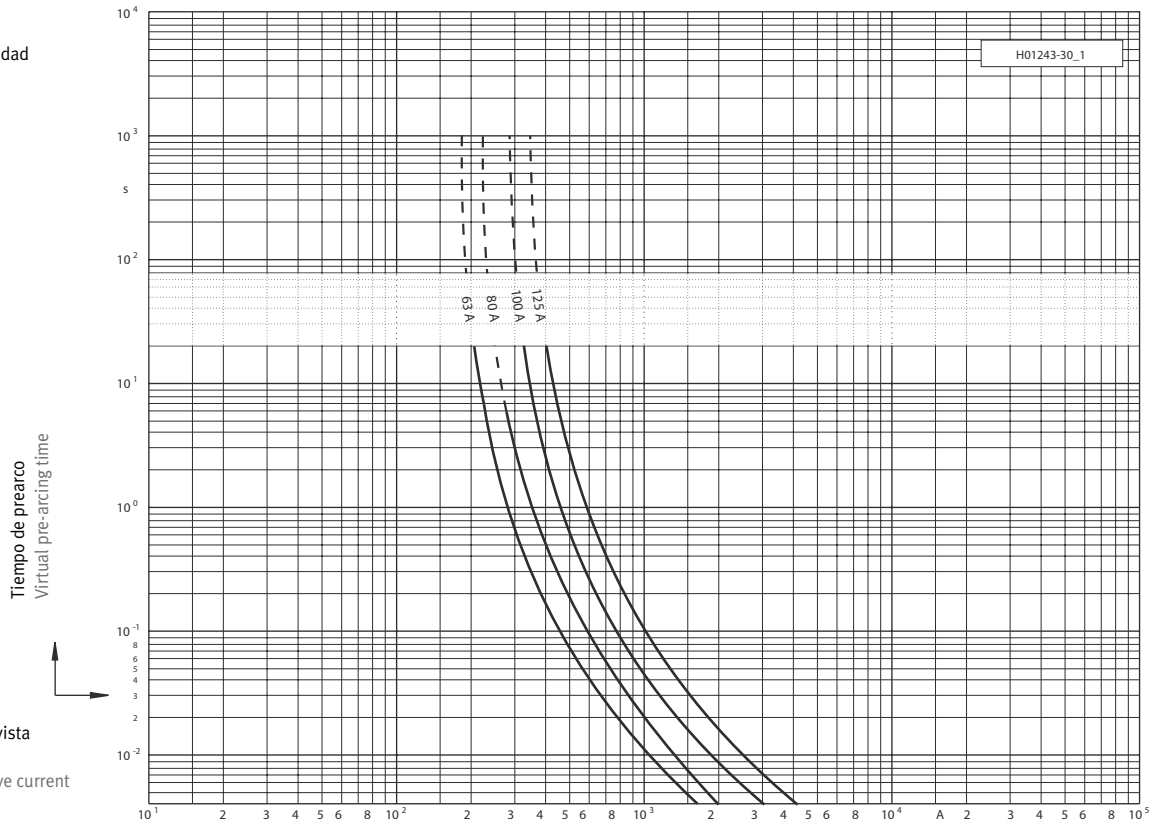

Característica
de limitación
Cut-off current

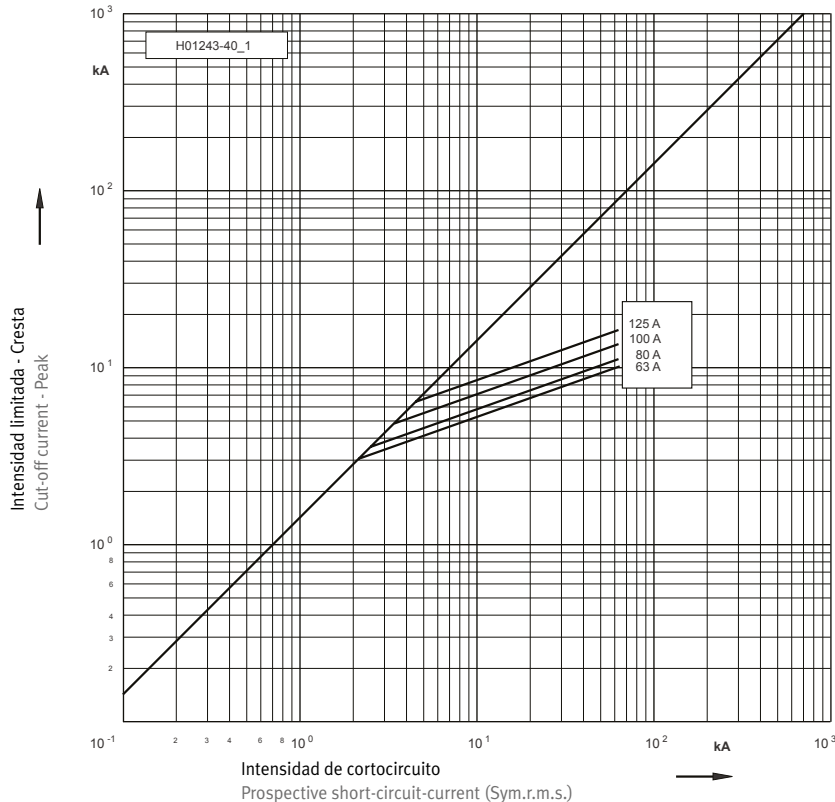

1



Curvas / Time current characteristics

10 / 24 kV

"e" = 442 mm

Característica
Tiempo-intensidad
Time-current
characteristic

Tiempo de prearco
Virtual pre-arcing time



Intensidad prevista
simétrica RMS
RMS prospective current

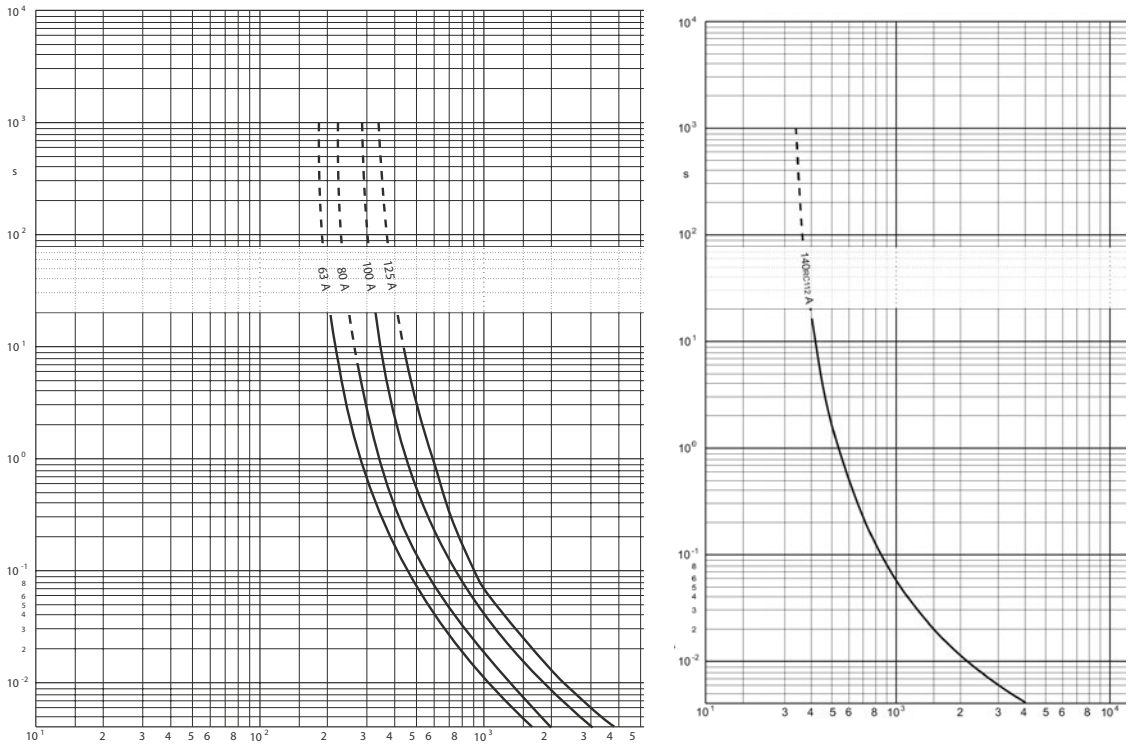

Característica
de limitación
Cut-off current

Intensidad limitada - Cresta
Cut-off current - Peak

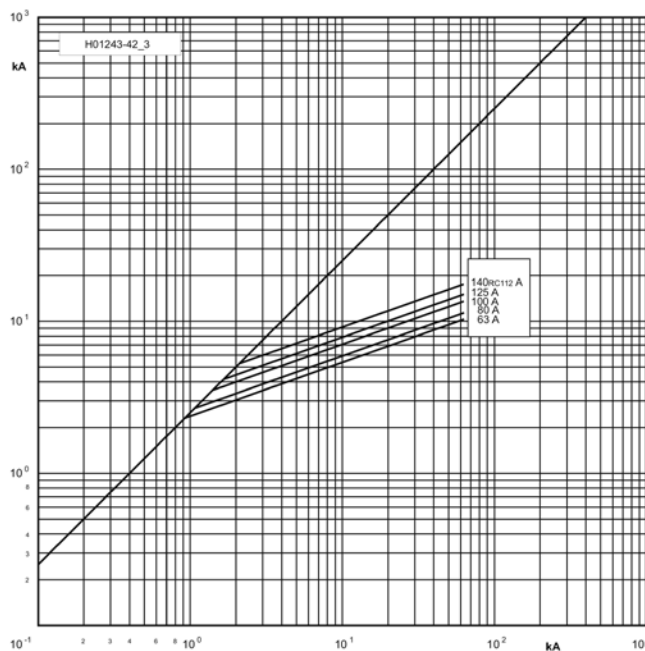

Intensidad de cortocircuito
Prospective short-circuit-current (Sym.r.m.s.)



1

Fusibles de acompañamiento de media tensión
HV – Back-up fuse links

Curvas / Time current characteristics



20 / 36 kV

"e" = 537 mm

Característica
Tiempo-intensidad
Time-current
characteristic

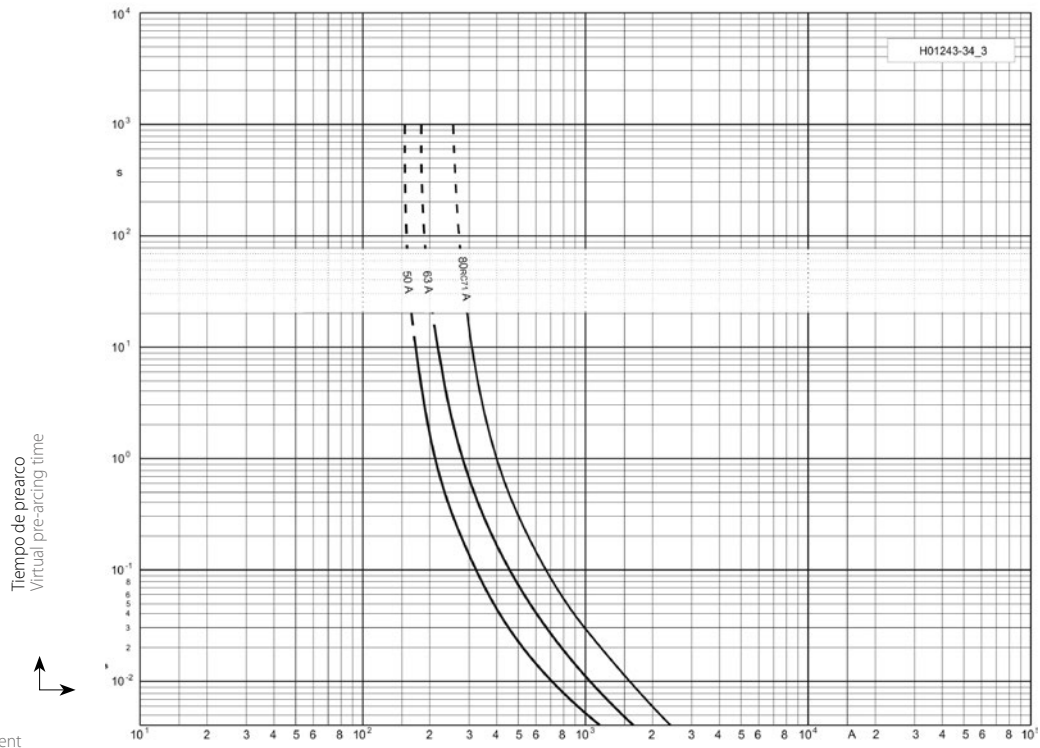

Intensidad prevista
simétrica RMS
RMS prospective current

Característica
de limitación
Cut-off current

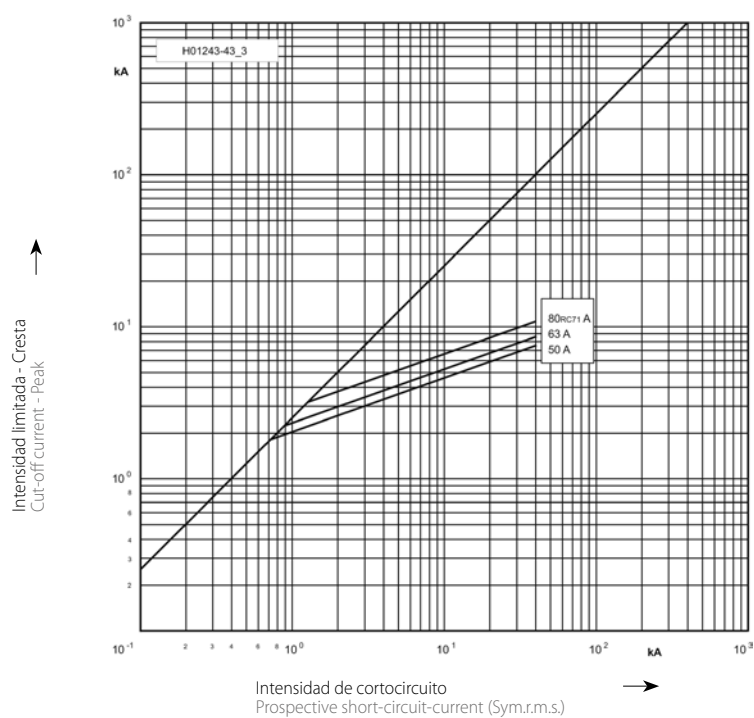

Intensidad de cortocircuito
Prospective short-circuit-current (Sym.r.m.s.)



Recomendaciones de uso / Recommendations for application

80 / 120 N

Diagrama Fuerza-Distancia / Force-Distance Diagram

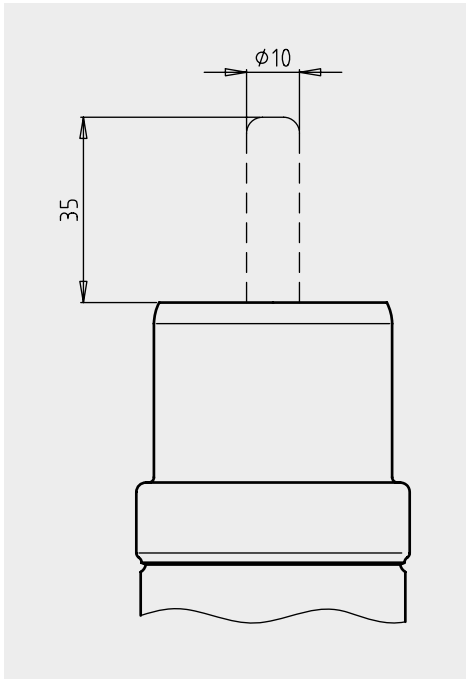

Percutor 80N
Fusibles de media tensión con percutor

Striker System 80 N
HV fuses with striker-pin

Referencia
Reference

30 xxx y3. zzz

Fuerza 80 N \cong 1.0 Joule
Withstand force

Tipo Medio
Type Medium

Referencia 30 xxx y3. zzz
Reference

Con Función de limitador de temperatura
Temperature-limiting function

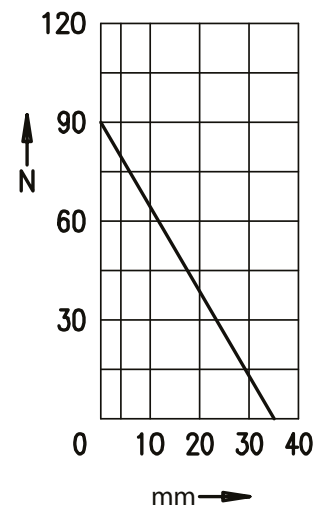

Percutor 120N
Fusibles HHD con percutor

Striker System 80 N
HHD fuses with striker-pin

Referencia
Reference

30 xxx y4. zzz

Fuerza 120 N \cong 1.5 Joule
Withstand force

Tipo Medio
Type Medium

Referencia 30 xxx y4. zzz
Reference

Sin Función de limitador de temperatura
No Temperature-limiting function

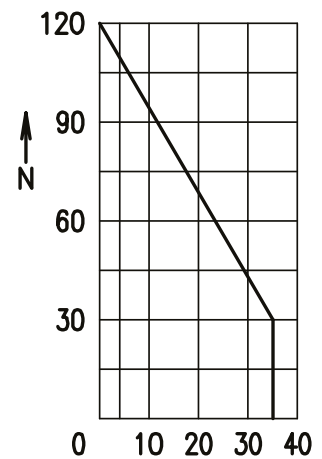

1



Protección de transformadores
Protection of transformers

Tabla de selección de fusibles de media tensión (Recomendada)
High voltage fuses selection guide (Recommended)

Tensión en kV Voltage (kV)	Tensión nominal en kV Rated Voltage (kV)	Potencia Nominal del transformador en kVA Transformer rated power (kVA)																
		25	50	75	100	125	160	200	250	315	400	500	630	800	1000	1250	1600	2000
Red Net	Fusible Fuse	Intensidad Nominal del fusible / Fuse Rated current																
10	6/12	6	10	16	16	16	20	25	31,5	40	50	63	80	100	125	160	200	250
13,5	10/24	4	6	10	10	16	16	20	25	31,5	40	50	63	80	100	125	160	200
15	10/24	4	6	10	10	10	16	16	20	25	31,5	40	50	63	80	100	125	160
20	10/24	4	6	10	10	10	10	16	16	20	25	31,5	40	50	63	80	100	125
25	20/36	2	4	6	6	10	10	10	16	16	20	25	31,5	40	50	63	80	80
30	20/36	2	4	6	6	6	10	10	10	16	16	20	25	31,5	40	50	63	80

Tabla de selección de fusibles de media tensión (Gama de utilización válida)
High voltage fuses selection guide (Valid operating range)

Tensión en kV Voltage (kV)	Tensión nominal en kV Rated Voltage (kV)	Potencia Nominal del transformador en kVA Transformer rated power (kVA)																
		25	50	75	100	125	160	200	250	315	400	500	630	800	1000	1250	1600	2000
Red Net	Fusible Fuse	Intensidad Nominal del fusible / Fuse Rated current																
10	6/12	3/6	6/16	10/20	16/20	16/40	20/40	25/50	31,5/63	40/80	50/100	63/125	80/200	100/200	125/200	160/250	200/250	250
13,5	10/24	3/6	6/10	10/16	10/20	16/25	16/31,5	20/40	25/50	31,5/63	40/80	50/100	63/125	80/160	100/125	125/160	160/200	200/250
15	10/24	3/4	4/10	6/16	10/16	10/25	16/31,5	16/40	20/40	25/63	31,5/63	40/80	50/100	63/125	80/125	100/125	125/200	160/250
20	10/24	2/4	3/6	6/10	6/16	10/16	10/20	16/25	16/40	20/40	25/50	31,5/63	40/80	50/100	63/80	80/100	100/125	125/200
25	20/36	2	3/4	4/6	6/10	6/16	10/20	10/25	16/31,5	16/31,5	20/40	25/50	31,5/63	40/100	50/63	63/80	80	80
30	20/36	2	3/4	3/6	4/10	6/10	10/16	10/20	10/25	16/31,5	16/40	20/50	25/50	31,5/63	40/63	50/80	63/80	80

Tablas de selección de fusibles de media tensión para protección de transformadores.
Información específica para red de distribución en España.
High voltage fuses for protection of transformer selection guide.
Specific information for Spain's distribution net.



Protección de condensadores Protection of capacitors

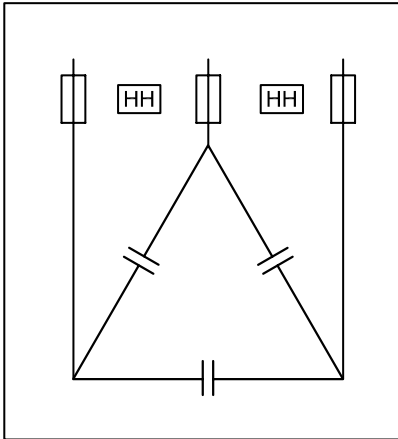

Recomendación para la protección de condensadores
Con fusibles HHD normativa DIN

Intensidades nominales de fusibles HHD de acuerdo con la capacidad nominal del condensador.

Recommendation for the protection of capacitors
with HHD Fuse-Links DIN standard

Assignment of rated currents of HHD fuse-links
to capacitor rated capacities

Para controlar el pico de tensión en la desconexión, el fusible se debe elegir en el siguiente rango más alto de tensión respecto de la tensión del funcionamiento del condensador.

Ej.: Para condensadores de 10 kV se deben escoger fusibles de 20 kV

To control the coccurring voltage during switch off fuse link should be chosen from the next higher voltage range.
E.g. 10 kV capacitor with 20 kV fuse links.

Potencia nominal del condensador Condenser Rated Capacity	Tensión de línea del condensador (kV) / Line voltage of the Capacitor (kV)					
	6 - 7,2		10 - 12		20 - 24	
	Fusibles de Media Tensión a escoger / HV fuses to choose					
	Tensión nominal Rated Voltage	Intensidad nominal Rated current	Tensión nominal Rated Voltage	Intensidad nominal Rated current	Tensión nominal Rated Voltage	Intensidad nominal Rated current
kVAr	kV	A	kV	A	kV	A
50	6/12	10	10/24	6,3	20/36	6,3
100	6/12	20	10/24	10	20/36	6,3
200	6/12	40	10/24	20	20/36	10
250	6/12	50	10/24	25	20/36	16
300	6/12	63	10/24	31,5	20/36	16
400	6/12	80	10/24	40	20/36	20
500	6/12	100	10/24	50	20/36	25
750	6/12	160	10/24	80	20/36	40
1.000	6/12	200	10/24	100	20/36	50
1.250	6/12	250	10/24	125	20/36	63
1.600	6/12	315	10/24	160	20/36	80
2.000	6/12	315	10/24	200	20/36	100



Protección de motores Protection of motors

Introducción

Para las necesidades de protección del circuito motor, las gamas más habituales de los fusibles SIBA son los siguientes:

Grupo de productos	Características	Referencia
HHD (Norma DIN)	TB De acompañamiento	30 xxx 1y.zzz
HHD (Norma DIN) y/o HHBM (Norma BS)	TBM De acompañamiento con característica motor	30 xxx 5y.zzz
HHAM (Norma DIN)	R-rated con característica motor	30 xxx 55.zzzR

Es imprescindible asegurarse de que el diagrama se utiliza correctamente, de lo contrario podría producirse una avería.

La norma IEC 60644 define un factor k , que es un factor de seguridad. Los diagramas de SIBA incluyen este factor de seguridad. Por lo tanto, se puede manejar este complicado factor, sin comprometer la seguridad.

Siempre que sea posible, los fusibles con características de motor han de ser escogidos por sus bajas pérdidas de energía. En caso de duda, consultar a Pronutec.

Selección

La selección de los fusibles comprende los siguientes parámetros:

- Datos del motor

Tensión nominal: U_{Mrated} Potencia nominal: P_{Mrated}
Factor de potencia: $\cos \varphi_M$ Rendimiento: η_M

- Datos del sistema

Tiempo de arranque, número de arranques por hora

- Máximo dos arranques consecutivos son admisibles en arranque directo

- Preselección de fusible

Tensión nominal y dimensiones mecánicas en condiciones de funcionamiento y montaje

- Corriente de arranque del motor (si no se conoce, normalmente $6 \times I_{Mnenn}$)

- Comprobar si la corriente nominal de los motores es <70% de la corriente nominal del fusible, si no, escoja el calibre inmediatamente superior y vuelva a realizar la comprobación.

- En el caso de condiciones especiales tales como:

- Temperatura ambiente >40° C

- Tiempo de arranque >60s

- Número de arranques >32/h

- Autotransformador o arranque suave

- Etc.

Consultar a Pronutec.

Introduction

For the needs of motor circuit protection, the most popular ranges of SIBA fuses are the following:

Product Group	Characteristic	Reference
HHD (DIN Standard)	TB (Teilbereich)	30 xxx 1y.zzz
HHD (DIN Standard) and / or HHBM (British Standard)	TBM Back-up with Motor-characteristic TBM Back-up with Motor-characteristic	30 xxx 5y.zzz
HHAM (DIN Standard)	R-rated with Motor-characteristic	30 xxx 55.zzzR

It is mandatory to ensure that the correct selection diagram is used.

Otherwise, malfunction may occur. IEC 60644 defines a k-factor, which in principal is a safety factor. The SIBA diagrams

include this safety factor. Therefore, the complicated handling of this factor can be avoided without compromising safety.

Whenever possible, fuses with motor characteristic should be preferred due to their very low power losses.

When in doubt, Pronutec should be consulted.

Selection

Fuse selection considers the following parameters:

- Motor data:

rated voltage: U_{Mrated} rated power: P_{Mrated}
power factor: $\cos \varphi_M$ efficiency: η_M

- System data:

Run-up time, number of starts per hour

- Max. two starts are permissible in direct succession

- Fuse preselection:

Rated voltage and mechanical dimensions acc. operating and assembly conditions

- Starting current of the motor (if unknown, typically $6 \times I_{Mnenn}$)

- Check, if the rated current of the motor is <70% of the rated fuse current. If not, use next higher fuse rating and recheck.

- In case of special conditions such as

- ambient temperature >40° C

- run-up time >60s

- number of starts >32/h

- auto-transformer or soft start

- etc.

Pronutec should be consulted.



Ejemplo de selección / Example for selection

Nº Arranques de motor / h
Motor starts / h

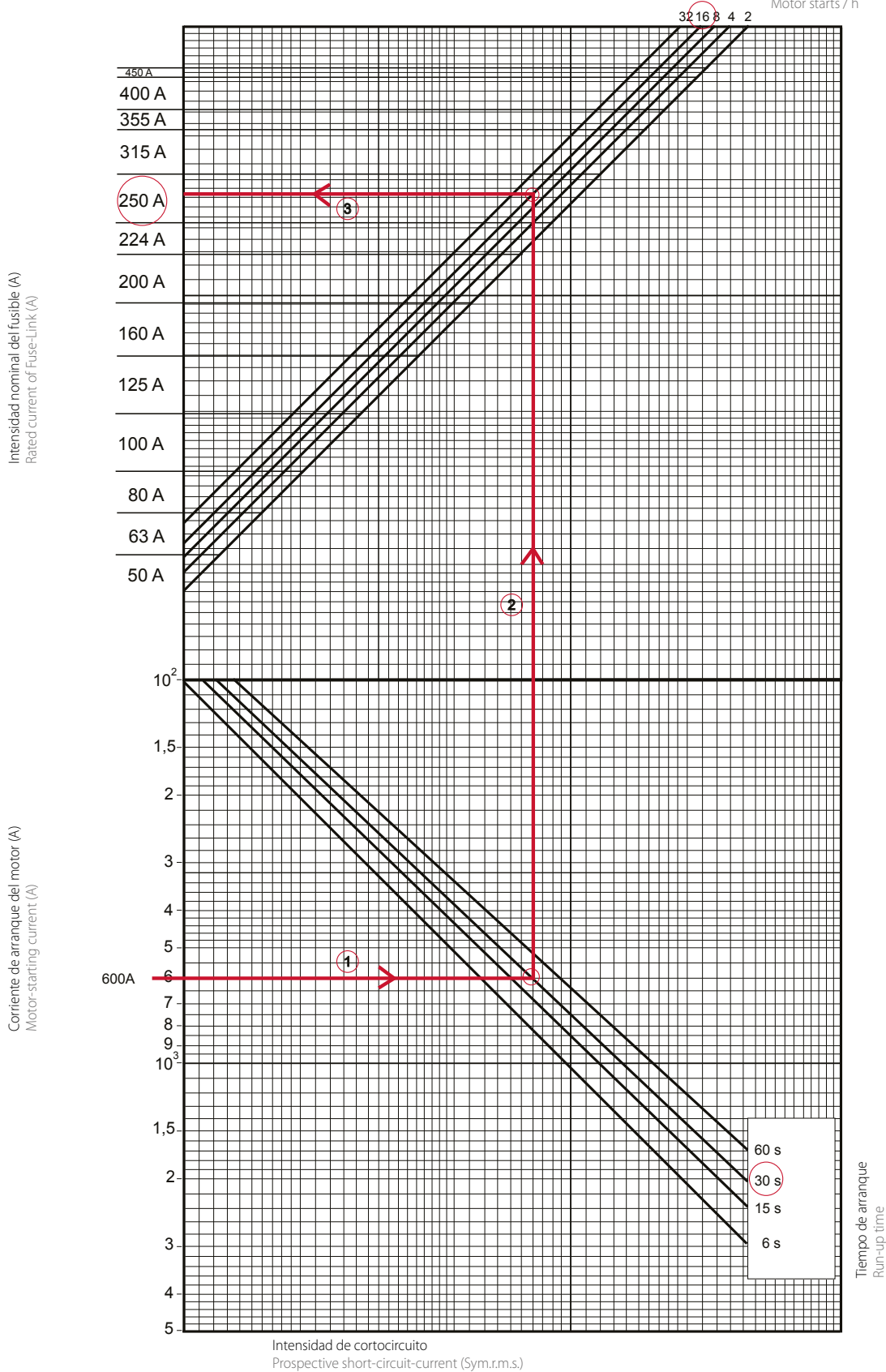



Fusibles HHD-B / HHD-B Fuses

30 xxx 1 yzzz

Nº Arranques de motor / h
Motor starts / h

